Appendix A – ATtiny25/V Specification at 105°C

This document contains information specific to devices operating at temperatures up to 105°C. Only deviations are covered in this appendix, all other information can be found in the complete datasheet. The complete datasheet can be found at www.atmel.com.



**8-bit AVR[®]
Microcontroller
with 2K Bytes
In-System
Programmable
Flash**

ATtiny25/V

Appendix A

Rev. 2586N–Appendix A–AVR–08/11





1. Electrical Characteristics

1.1 Absolute Maximum Ratings*

Operating Temperature.....	-55°C to +125°C
Storage Temperature.....	-65°C to +150°C
Voltage on any Pin except $\overline{\text{RESET}}$ with respect to Ground.....	-0.5V to $V_{CC}+0.5V$
Voltage on $\overline{\text{RESET}}$ with respect to Ground.....	-0.5V to +13.0V
Maximum Operating Voltage.....	6.0V
DC Current per I/O Pin.....	40.0 mA
DC Current V_{CC} and GND Pins.....	200.0 mA

*NOTICE: Stresses beyond those listed under “Absolute Maximum Ratings” may cause permanent damage to the device. This is a stress rating only and functional operation of the device at these or other conditions beyond those indicated in the operational sections of this specification is not implied. Exposure to absolute maximum rating conditions for extended periods may affect device reliability.

1.2 DC Characteristics

Table 1-1. DC Characteristics. $T_A = -40^\circ\text{C}$ to $+105^\circ\text{C}$

Symbol	Parameter	Condition	Min.	Typ. ⁽¹⁾	Max.	Units
V_{IL}	Input Low-voltage, except XTAL1 and $\overline{\text{RESET}}$ pin	$V_{CC} = 1.8V - 2.4V$	-0.5		$0.2V_{CC}^{(3)}$	V
		$V_{CC} = 2.4V - 5.5V$	-0.5		$0.3V_{CC}^{(3)}$	V
V_{IH}	Input High-voltage, except XTAL1 and $\overline{\text{RESET}}$ pin	$V_{CC} = 1.8V - 2.4V$	$0.7V_{CC}^{(2)}$		$V_{CC} + 0.5$	V
		$V_{CC} = 2.4V - 5.5V$	$0.6V_{CC}^{(2)}$		$V_{CC} + 0.5$	V
V_{IL1}	Input Low-voltage, XTAL1 pin, External Clock Selected	$V_{CC} = 1.8V - 5.5V$	-0.5		$0.1V_{CC}^{(3)}$	V
V_{IH1}	Input High-voltage, XTAL1 pin, External Clock Selected	$V_{CC} = 1.8V - 2.4V$	$0.8V_{CC}^{(2)}$		$V_{CC} + 0.5$	V
		$V_{CC} = 2.4V - 5.5V$	$0.7V_{CC}^{(2)}$		$V_{CC} + 0.5$	V
V_{IL2}	Input Low-voltage, $\overline{\text{RESET}}$ pin	$V_{CC} = 1.8V - 5.5V$	-0.5		$0.2V_{CC}^{(3)}$	V
V_{IH2}	Input High-voltage, $\overline{\text{RESET}}$ pin	$V_{CC} = 1.8V - 5.5V$	$0.9V_{CC}^{(2)}$		$V_{CC} + 0.5$	V
V_{IL3}	Input Low-voltage, $\overline{\text{RESET}}$ pin as I/O	$V_{CC} = 1.8V - 2.4V$	-0.5		$0.2V_{CC}^{(3)}$	V
		$V_{CC} = 2.4V - 5.5V$	-0.5		$0.3V_{CC}^{(3)}$	V
V_{IH3}	Input High-voltage, $\overline{\text{RESET}}$ pin as I/O	$V_{CC} = 1.8V - 2.4V$	$0.7V_{CC}^{(2)}$		$V_{CC} + 0.5$	V
		$V_{CC} = 2.4V - 5.5V$	$0.6V_{CC}^{(2)}$		$V_{CC} + 0.5$	V
V_{OL}	Output Low-voltage ⁽⁴⁾ , Port B (except $\overline{\text{RESET}}$) ⁽⁶⁾	$I_{OL} = 10\text{ mA}, V_{CC} = 5V$			0.6	V
		$I_{OL} = 5\text{ mA}, V_{CC} = 3V$			0.5	V
V_{OH}	Output High-voltage ⁽⁵⁾ , Port B (except $\overline{\text{RESET}}$) ⁽⁶⁾	$I_{OH} = -10\text{ mA}, V_{CC} = 5V$	4.3			V
		$I_{OH} = -5\text{ mA}, V_{CC} = 3V$	2.5			V
I_{IL}	Input Leakage Current I/O Pin	$V_{CC} = 5.5V$, pin low (absolute value)		< 0.05	1	μA
I_{IH}	Input Leakage Current I/O Pin	$V_{CC} = 5.5V$, pin high (absolute value)		< 0.05	1	μA

Table 1-1. DC Characteristics. $T_A = -40^{\circ}\text{C}$ to $+105^{\circ}\text{C}$ (Continued)

Symbol	Parameter	Condition	Min.	Typ. ⁽¹⁾	Max.	Units	
R_{RST}	Reset Pull-up Resistor	$V_{CC} = 5.5\text{V}$, input low	30		60	$k\Omega$	
R_{pu}	I/O Pin Pull-up Resistor	$V_{CC} = 5.5\text{V}$, input low	20		50	$k\Omega$	
I_{CC}	Power Supply Current ⁽⁷⁾	Active 1MHz, $V_{CC} = 2\text{V}$		0.3	0.55	mA	
		Active 4MHz, $V_{CC} = 3\text{V}$		1.5	2.5	mA	
		Active 8MHz, $V_{CC} = 5\text{V}$		5	8	mA	
		Idle 1MHz, $V_{CC} = 2\text{V}$		0.1	0.2	mA	
		Idle 4MHz, $V_{CC} = 3\text{V}$		0.35	0.6	mA	
		Idle 8MHz, $V_{CC} = 5\text{V}$		1.2	2	mA	
	Power-down mode ⁽⁸⁾	WDT enabled, $V_{CC} = 3\text{V}$			4	20	μA
		WDT disabled, $V_{CC} = 3\text{V}$			0.2	10	μA

- Notes:
1. Typical values at 25°C .
 2. "Min" means the lowest value where the pin is guaranteed to be read as high.
 3. "Max" means the highest value where the pin is guaranteed to be read as low.
 4. Although each I/O port can sink more than the test conditions (10 mA at $V_{CC} = 5\text{V}$, 5 mA at $V_{CC} = 3\text{V}$) under steady state conditions (non-transient), the following must be observed:
 - 1] The sum of all IOL, for all ports, should not exceed 60 mA.
 If IOL exceeds the test condition, VOL may exceed the related specification. Pins are not guaranteed to sink current greater than the listed test condition.
 5. Although each I/O port can source more than the test conditions (10 mA at $V_{CC} = 5\text{V}$, 5 mA at $V_{CC} = 3\text{V}$) under steady state conditions (non-transient), the following must be observed:
 - 1] The sum of all IOH, for all ports, should not exceed 60 mA.
 If IOH exceeds the test condition, VOH may exceed the related specification. Pins are not guaranteed to source current greater than the listed test condition.
 6. The $\overline{\text{RESET}}$ pin must tolerate high voltages when entering and operating in programming modes and, as a consequence, has a weak drive strength as compared to regular I/O pins.
 7. Values are with external clock using methods described in ["Minimizing Power Consumption" on page 37](#). Power Reduction is enabled (PRR = 0xFF) and there is no I/O drive.
 8. Brown-Out Detection (BOD) disabled.

1.3 Clock Characteristics

1.3.1 Calibrated Internal RC Oscillator Accuracy

It is possible to manually calibrate the internal oscillator to be more accurate than default factory calibration. Please note that the oscillator frequency depends on temperature and voltage. Voltage and temperature characteristics can be found in [Figure 2-36 on page 28](#) and [Figure 2-37 on page 28](#).

Table 1-2. Calibration Accuracy of Internal RC Oscillator

Calibration Method	Target Frequency	V _{CC}	Temperature	Accuracy at given Voltage & Temperature ⁽¹⁾
Factory Calibration	8.0 MHz ⁽²⁾	3V	25°C	±10%
User Calibration	Fixed frequency within: 6 – 8 MHz	Fixed voltage within: 1.8V - 5.5V ⁽³⁾ 2.7V - 5.5V ⁽⁴⁾	Fixed temperature within: -40°C to +105°C	±1%

- Notes:
1. Accuracy of oscillator frequency at calibration point (fixed temperature and fixed voltage).
 2. ATtiny25/V, only: 6.4 MHz in ATtiny15 Compatibility Mode.
 3. Voltage range for ATtiny25V.
 4. Voltage range for ATtiny25.

1.4 System and Reset Characteristics

Table 1-3. Reset, Brown-out and Internal Voltage Characteristics

Symbol	Parameter	Condition	Min ⁽¹⁾	Typ ⁽¹⁾	Max ⁽¹⁾	Units
V _{RST}	$\overline{\text{RESET}}$ Pin Threshold Voltage	V _{CC} = 3V	0.2 V _{CC}		0.9 V _{CC}	V
t _{RST}	Minimum pulse width on $\overline{\text{RESET}}$ Pin	V _{CC} = 3V			2.5	µs
V _{HYST}	Brown-out Detector Hysteresis			50		mV
t _{BOD}	Min Pulse Width on Brown-out Reset			2		µs
V _{BG}	Bandgap reference voltage	V _{CC} = 5.5V T _A = 25°C	1.0	1.1	1.2	V
t _{BG}	Bandgap reference start-up time	V _{CC} = 2.7V T _A = 25°C		40	70	µs
I _{BG}	Bandgap reference current consumption	V _{CC} = 2.7V T _A = 25°C		15		µA

Note: 1. Values are guidelines only.

1.4.1 Enhanced Power-On Reset

The table below describes the characteristics of the power-on reset.

Table 1-4. Characteristics of Enhanced Power-On Reset. $T_A = -40^{\circ}\text{C}$ to $+105^{\circ}\text{C}$

Symbol	Parameter	Min ⁽¹⁾	Typ ⁽¹⁾	Max ⁽¹⁾	Units
V_{POR}	Release threshold of power-on reset ⁽²⁾	1.1	1.4	1.7	V
V_{POA}	Activation threshold of power-on reset ⁽³⁾	0.6	1.3	1.7	V
SR_{ON}	Power-On Slope Rate	0.01			V/ms

- Note:
1. Values are guidelines, only
 2. Threshold where device is released from reset when voltage is rising
 3. The Power-on Reset will not work unless the supply voltage has been below V_{POT} (falling)

1.5 ADC Characteristics – Preliminary

Table 1-5. ADC Characteristics, Single Ended Channels. $T_A = -40^{\circ}\text{C}$ to $+105^{\circ}\text{C}$

Symbol	Parameter	Condition	Min	Typ	Max	Units
	Resolution				10	Bits
	Absolute accuracy (Including INL, DNL, and Quantization, Gain and Offset errors)	$V_{REF} = 4\text{V}$, $V_{CC} = 4\text{V}$, ADC clock = 200 kHz		2		LSB
		$V_{REF} = 4\text{V}$, $V_{CC} = 4\text{V}$, ADC clock = 1 MHz		3		LSB
		$V_{REF} = 4\text{V}$, $V_{CC} = 4\text{V}$, ADC clock = 200 kHz Noise Reduction Mode		1.5		LSB
		$V_{REF} = 4\text{V}$, $V_{CC} = 4\text{V}$, ADC clock = 1 MHz Noise Reduction Mode		2.5		LSB
	Integral Non-linearity (INL) (Accuracy after offset and gain calibration)	$V_{REF} = 4\text{V}$, $V_{CC} = 4\text{V}$, ADC clock = 200 kHz		1		LSB
	Differential Non-linearity (DNL)	$V_{REF} = 4\text{V}$, $V_{CC} = 4\text{V}$, ADC clock = 200 kHz		0.5		LSB
	Gain Error	$V_{REF} = 4\text{V}$, $V_{CC} = 4\text{V}$, ADC clock = 200 kHz		2.5		LSB
	Offset Error	$V_{REF} = 4\text{V}$, $V_{CC} = 4\text{V}$, ADC clock = 200 kHz		1.5		LSB
	Conversion Time	Free Running Conversion	14		280	μs
	Clock Frequency		50		1000	kHz
V_{IN}	Input Voltage		GND		V_{REF}	V
	Input Bandwidth			38.4		kHz
A_{REF}	External Reference Voltage		2.0		V_{CC}	V
V_{INT}	Internal Voltage Reference		1.0	1.1	1.2	V
	Internal 2.56V Reference ⁽¹⁾	$V_{CC} > 3.0\text{V}$	2.3	2.56	2.8	V
R_{REF}				32		$\text{k}\Omega$
R_{AIN}	Analog Input Resistance			100		$\text{M}\Omega$
	ADC Output		0		1023	LSB

Note: 1. Values are guidelines only.

Table 1-6. ADC Characteristics, Differential Channels (Unipolar Mode). $T_A = -40^{\circ}\text{C}$ to $+105^{\circ}\text{C}$

Symbol	Parameter	Condition	Min	Typ	Max	Units
	Resolution	Gain = 1x			10	Bits
		Gain = 20x			10	Bits
	Absolute accuracy (Including INL, DNL, and Quantization, Gain and Offset Errors)	Gain = 1x $V_{REF} = 4V, V_{CC} = 5V$ ADC clock = 50 - 200 kHz		10.0		LSB
		Gain = 20x $V_{REF} = 4V, V_{CC} = 5V$ ADC clock = 50 - 200 kHz			20.0	
	Integral Non-Linearity (INL) (Accuracy after Offset and Gain Calibration)	Gain = 1x $V_{REF} = 4V, V_{CC} = 5V$ ADC clock = 50 - 200 kHz		4.0		LSB
		Gain = 20x $V_{REF} = 4V, V_{CC} = 5V$ ADC clock = 50 - 200 kHz			10.0	
	Gain Error	Gain = 1x		10.0		LSB
		Gain = 20x			15.0	
	Offset Error	Gain = 1x $V_{REF} = 4V, V_{CC} = 5V$ ADC clock = 50 - 200 kHz		3.0		LSB
		Gain = 20x $V_{REF} = 4V, V_{CC} = 5V$ ADC clock = 50 - 200 kHz			4.0	
	Conversion Time	Free Running Conversion	70		280	μs
	Clock Frequency		50		200	kHz
V_{IN}	Input Voltage		GND		V_{CC}	V
V_{DIFF}	Input Differential Voltage				V_{REF}/Gain	V
	Input Bandwidth			4		kHz
AREF	External Reference Voltage		2.0		$V_{CC} - 1.0$	V
V_{INT}	Internal Voltage Reference		1.0	1.1	1.2	V
	Internal 2.56V Reference ⁽¹⁾	$V_{CC} > 3.0V$	2.3	2.56	2.8	V
R_{REF}	Reference Input Resistance			32		$k\Omega$
R_{AIN}	Analog Input Resistance			100		$M\Omega$
	ADC Conversion Output		0		1023	LSB

Note: 1. Values are guidelines only.

Table 1-7. ADC Characteristics, Differential Channels (Bipolar Mode). $T_A = -40^{\circ}\text{C}$ to $+105^{\circ}\text{C}$

Symbol	Parameter	Condition	Min	Typ	Max	Units
	Resolution	Gain = 1x			10	Bits
		Gain = 20x			10	Bits
	Absolute accuracy (Including INL, DNL, and Quantization, Gain and Offset Errors)	Gain = 1x $V_{REF} = 4V, V_{CC} = 5V$ ADC clock = 50 - 200 kHz		8.0		LSB
		Gain = 20x $V_{REF} = 4V, V_{CC} = 5V$ ADC clock = 50 - 200 kHz		8.0		LSB
	Integral Non-Linearity (INL) (Accuracy after Offset and Gain Calibration)	Gain = 1x $V_{REF} = 4V, V_{CC} = 5V$ ADC clock = 50 - 200 kHz		4.0		LSB
		Gain = 20x $V_{REF} = 4V, V_{CC} = 5V$ ADC clock = 50 - 200 kHz		5.0		LSB
	Gain Error	Gain = 1x		4.0		LSB
		Gain = 20x		5.0		LSB
	Offset Error	Gain = 1x $V_{REF} = 4V, V_{CC} = 5V$ ADC clock = 50 - 200 kHz		3.0		LSB
		Gain = 20x $V_{REF} = 4V, V_{CC} = 5V$ ADC clock = 50 - 200 kHz		4.0		LSB
	Conversion Time	Free Running Conversion	70		280	μs
	Clock Frequency		50		200	kHz
V_{IN}	Input Voltage		GND		V_{CC}	V
V_{DIFF}	Input Differential Voltage				V_{REF}/Gain	V
	Input Bandwidth			4		kHz
A_{REF}	External Reference Voltage		2.0		$V_{CC} - 1.0$	V
V_{INT}	Internal Voltage Reference		1.0	1.1	1.2	V
	Internal 2.56V Reference ⁽¹⁾	$V_{CC} > 3.0V$	2.3	2.56	2.8	V
R_{REF}	Reference Input Resistance			32		$k\Omega$
R_{AIN}	Analog Input Resistance			100		$M\Omega$
	ADC Conversion Output		-512		511	LSB

Note: 1. Values are guidelines only.

1.6 Serial Programming Characteristics

Figure 1-1. Serial Programming Waveforms

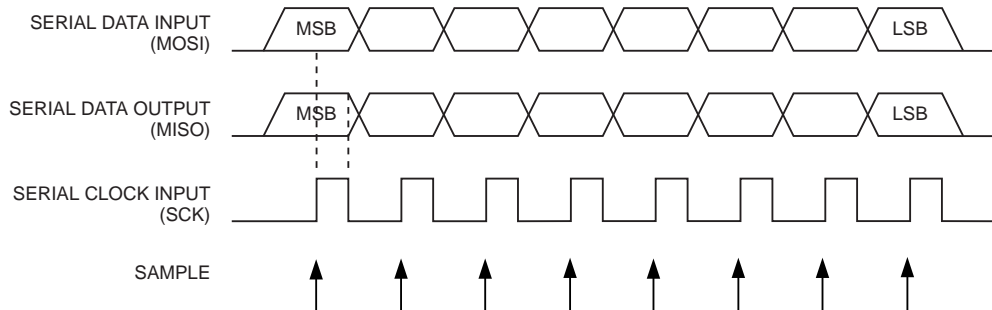

Figure 1-2. Serial Programming Timing

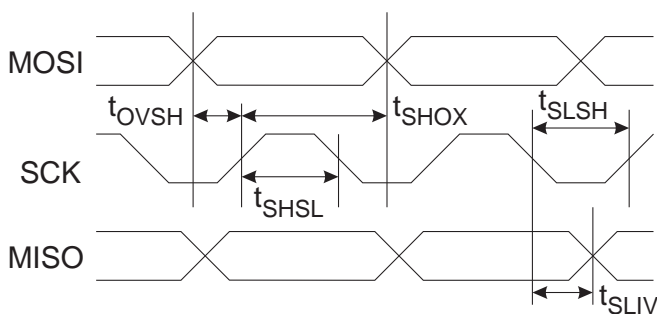

Table 1-8. Serial Programming Characteristics, $T_A = -40^{\circ}\text{C}$ to $+105^{\circ}\text{C}$, $V_{CC} = 1.8 - 5.5\text{V}$ (Unless Otherwise Noted)

Symbol	Parameter	Min	Typ	Max	Units
$1/t_{\text{CLCL}}$	Oscillator Frequency ($V_{\text{CC}} = 1.8 - 5.5\text{V}$)	0		4	MHz
t_{CLCL}	Oscillator Period ($V_{\text{CC}} = 1.8 - 5.5\text{V}$)	250			ns
$1/t_{\text{CLCL}}$	Oscillator Frequency ($V_{\text{CC}} = 2.7 - 5.5\text{V}$)	0		10	MHz
t_{CLCL}	Oscillator Period ($V_{\text{CC}} = 2.7 - 5.5\text{V}$)	100			ns
$1/t_{\text{CLCL}}$	Oscillator Frequency ($V_{\text{CC}} = 4.5\text{V} - 5.5\text{V}$)	0		20	MHz
t_{CLCL}	Oscillator Period ($V_{\text{CC}} = 4.5\text{V} - 5.5\text{V}$)	50			ns
t_{SHSL}	SCK Pulse Width High	$2 t_{\text{CLCL}}^*$			ns
t_{SLSH}	SCK Pulse Width Low	$2 t_{\text{CLCL}}^*$			ns
t_{OVSH}	MOSI Setup to SCK High	t_{CLCL}			ns
t_{SHOX}	MOSI Hold after SCK High	$2 t_{\text{CLCL}}$			ns
t_{SLIV}	SCK Low to MISO Valid			100	ns

Note: 1. $2 t_{\text{CLCL}}$ for $f_{\text{ck}} < 12\text{ MHz}$, $3 t_{\text{CLCL}}$ for $f_{\text{ck}} \geq 12\text{ MHz}$

2. Typical Characteristics

The data contained in this section is largely based on simulations and characterization of similar devices in the same process and design methods. Thus, the data should be treated as indications of how the part will behave.

The following charts show typical behavior. These figures are not tested during manufacturing. All current consumption measurements are performed with all I/O pins configured as inputs and with internal pull-ups enabled. A sine wave generator with rail-to-rail output is used as clock source.

The power consumption in Power-down mode is independent of clock selection.

The current consumption is a function of several factors such as: operating voltage, operating frequency, loading of I/O pins, switching rate of I/O pins, code executed and ambient temperature. The dominating factors are operating voltage and frequency.

The current drawn from capacitive loaded pins may be estimated (for one pin) as $C_L * V_{CC} * f$ where C_L = load capacitance, V_{CC} = operating voltage and f = average switching frequency of I/O pin.

The parts are characterized at frequencies higher than test limits. Parts are not guaranteed to function properly at frequencies higher than the ordering code indicates.

The difference between current consumption in Power-down mode with Watchdog Timer enabled and Power-down mode with Watchdog Timer disabled represents the differential current drawn by the Watchdog Timer.

2.1 Active Supply Current

Figure 2-1. Active Supply Current vs. V_{CC} (Internal RC oscillator, 8 MHz)

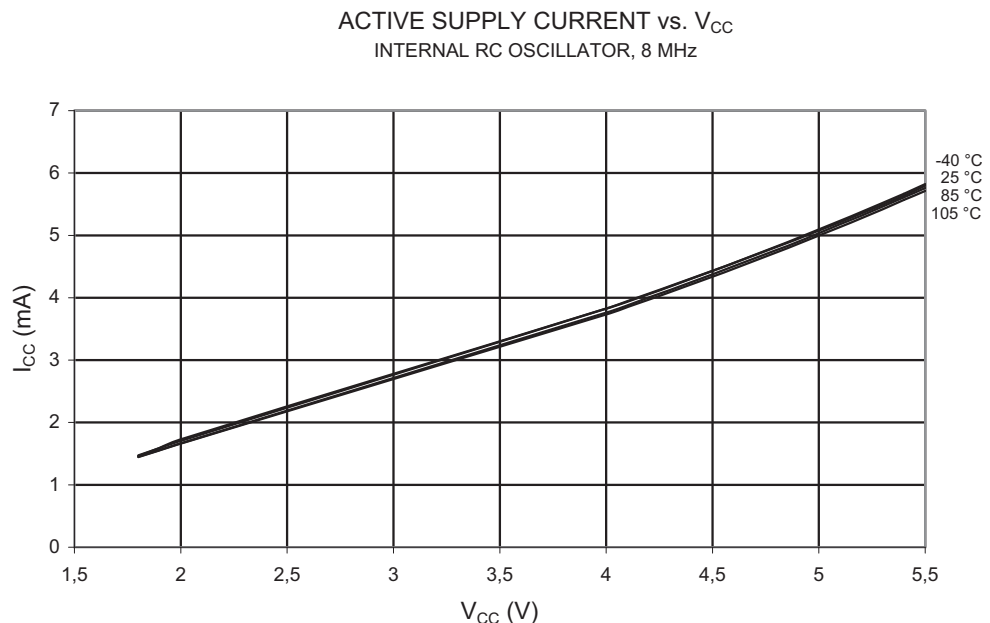

Figure 2-2. Active Supply Current vs. V_{CC} (Internal RC Oscillator, 1 MHz)

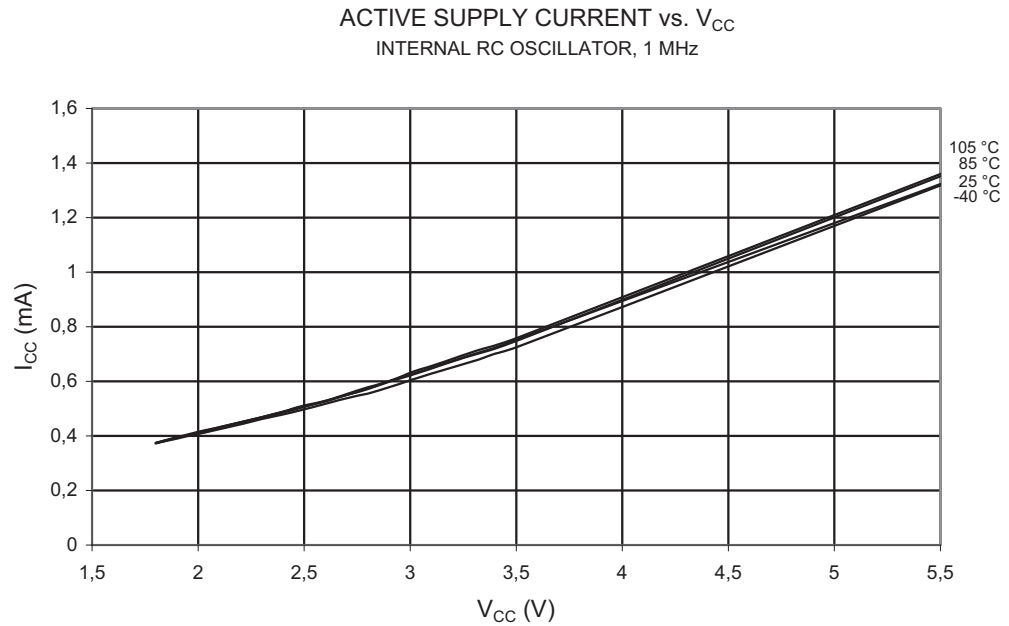
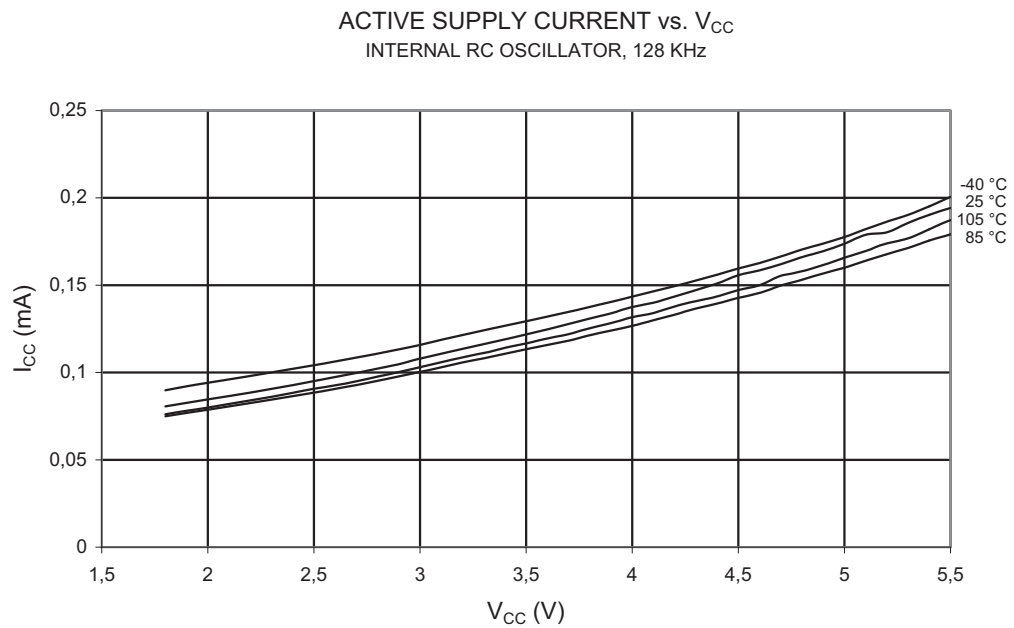

Figure 2-3. Active Supply Current vs. V_{CC} (Internal RC Oscillator, 128 kHz)



2.2 Idle Supply Current

Figure 2-4. Idle Supply Current vs. V_{CC} (Internal RC Oscillator, 8 MHz)

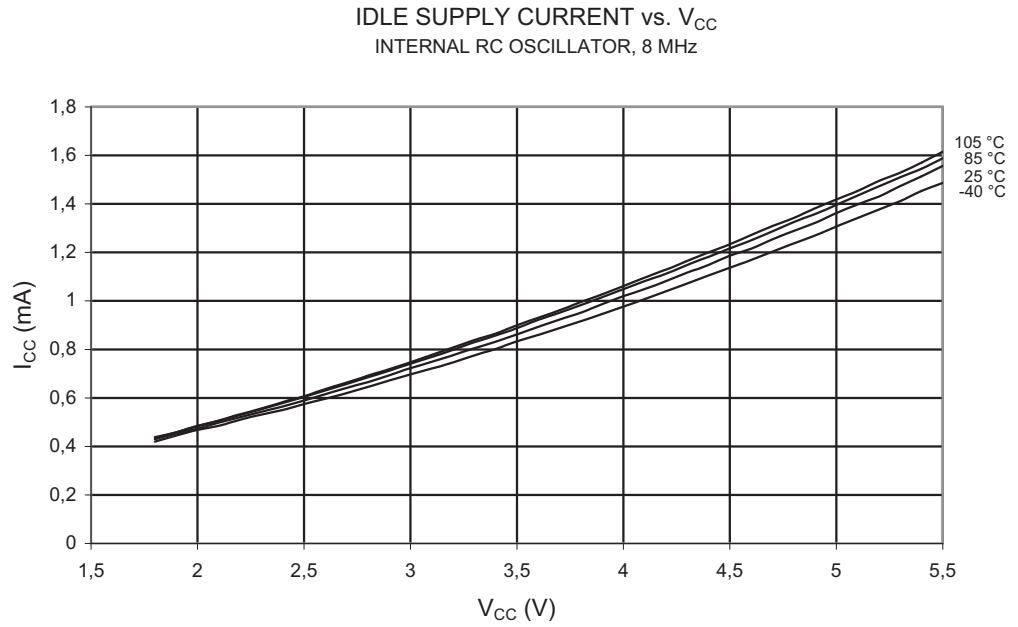

Figure 2-5. Idle Supply Current vs. V_{CC} (Internal RC Oscillator, 1 MHz)

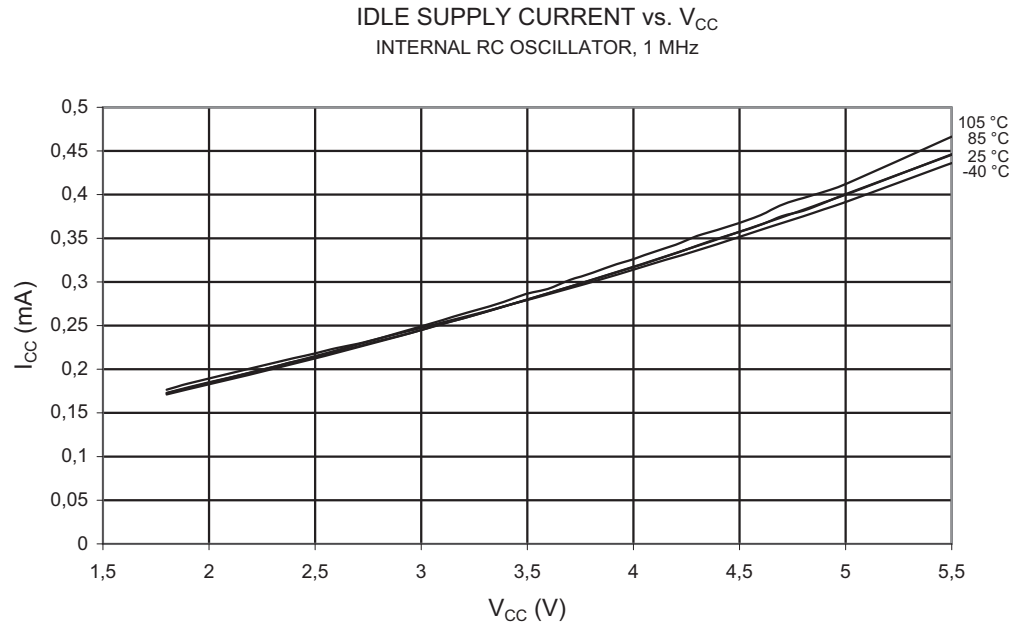
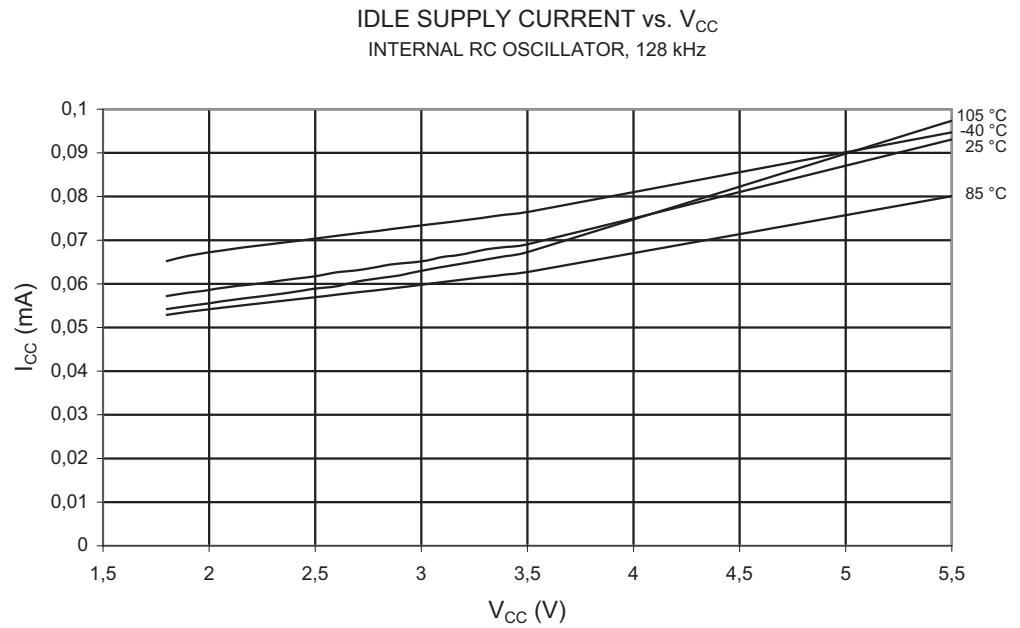

Figure 2-6. Idle Supply Current vs. V_{CC} (Internal RC Oscillator, 128 kHz)



2.3 Power-down Supply Current

Figure 2-7. Power-down Supply Current vs. V_{CC} (Watchdog Timer Disabled)

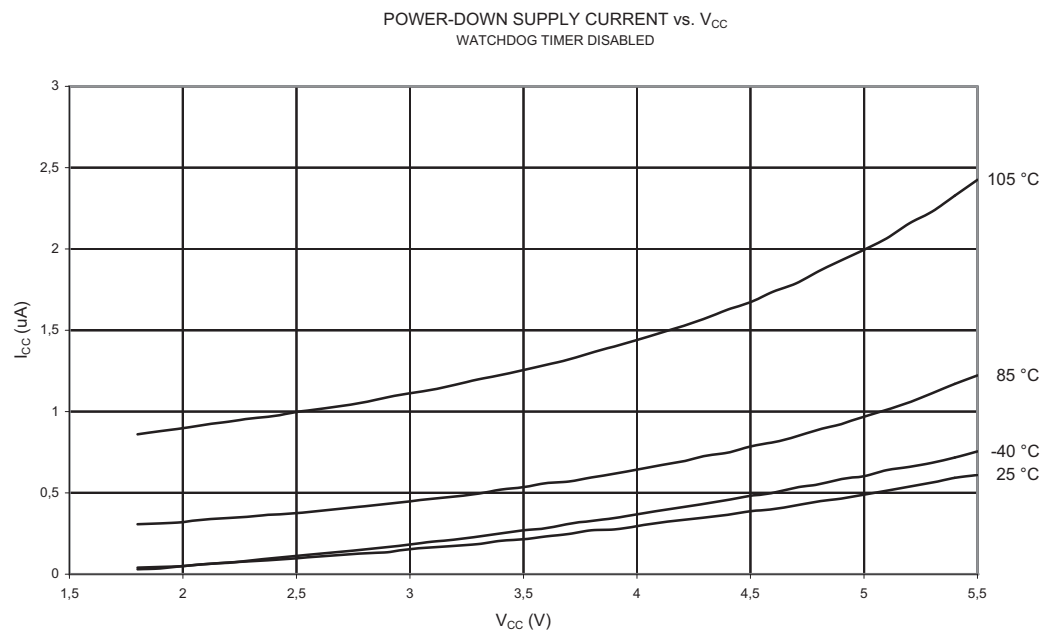
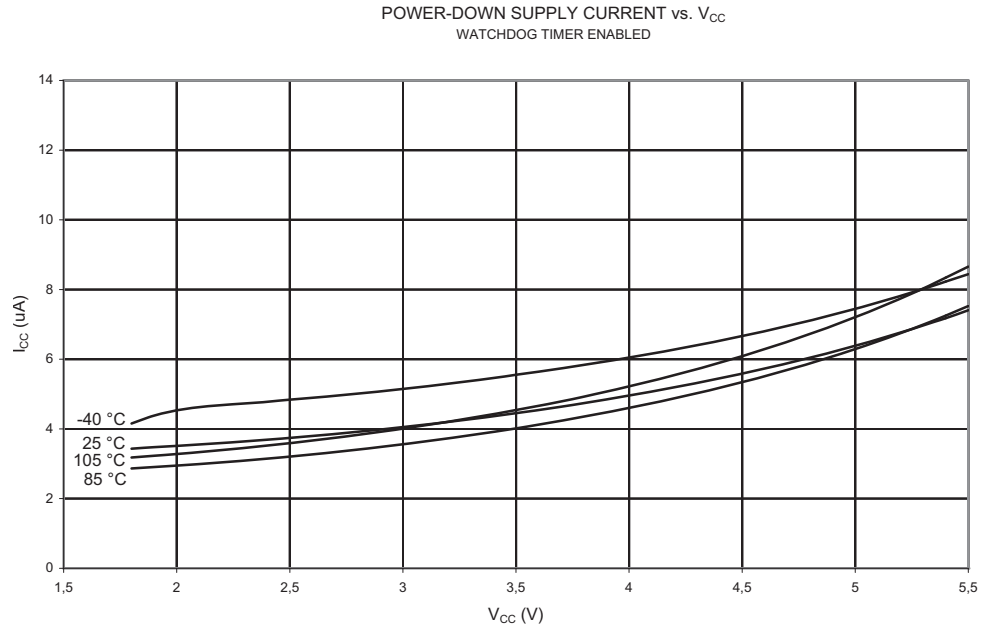

Figure 2-8. Power-down Supply Current vs. V_{CC} (Watchdog Timer Enabled)



2.4 Pin Pull-up

Figure 2-9. I/O Pin Pull-up Resistor Current vs. Input Voltage ($V_{CC} = 1.8V$)

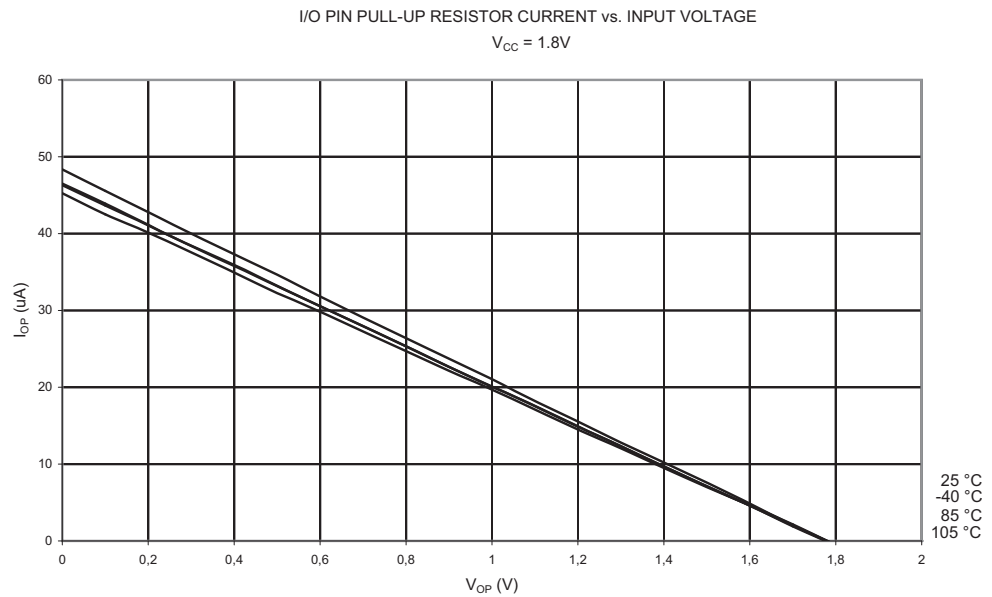

Figure 2-10. I/O Pin Pull-up Resistor Current vs. Input Voltage ($V_{CC} = 2.7V$)

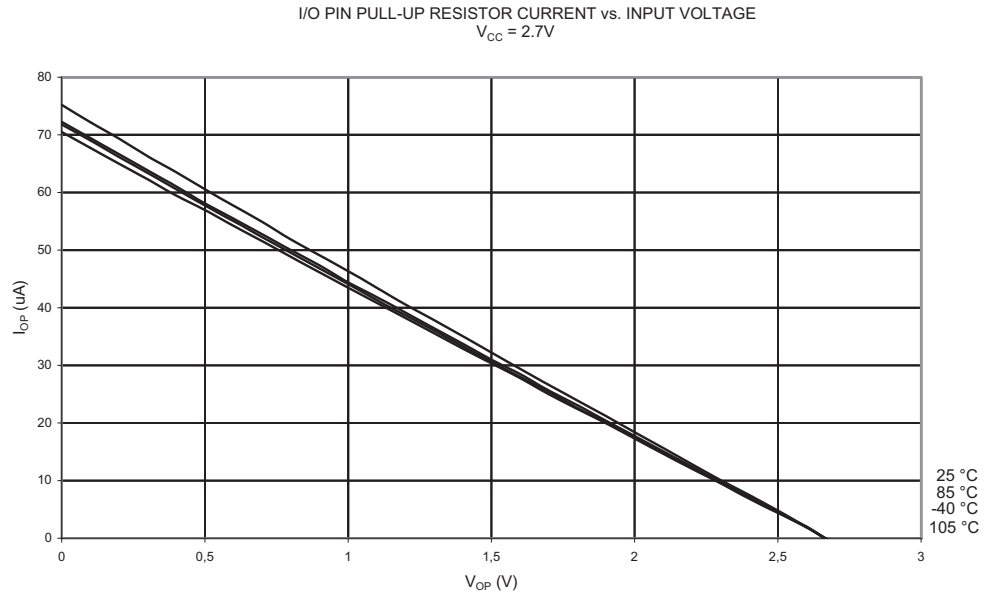

Figure 2-11. I/O Pin Pull-up Resistor Current vs. Input Voltage ($V_{CC} = 5V$)

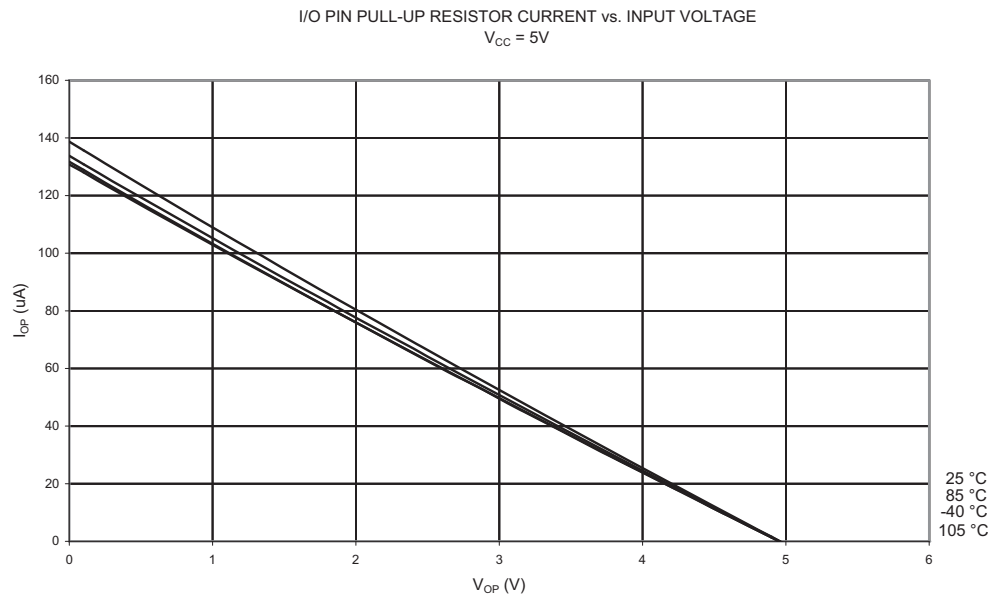

Figure 2-12. Reset Pull-up Resistor Current vs. Reset Pin Voltage ($V_{CC} = 1.8V$)

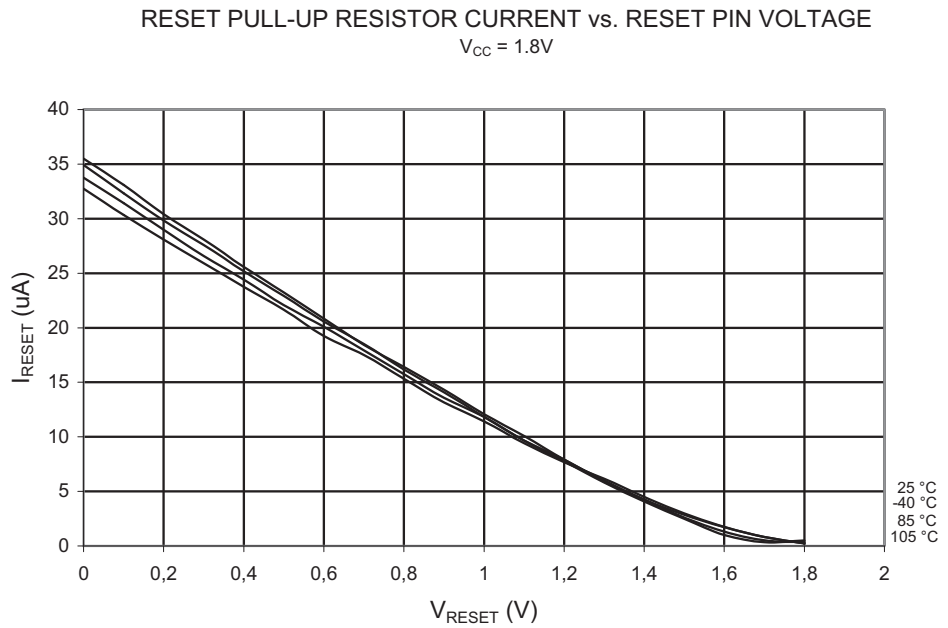

Figure 2-13. Reset Pull-up Resistor Current vs. Reset Pin Voltage ($V_{CC} = 2.7V$)

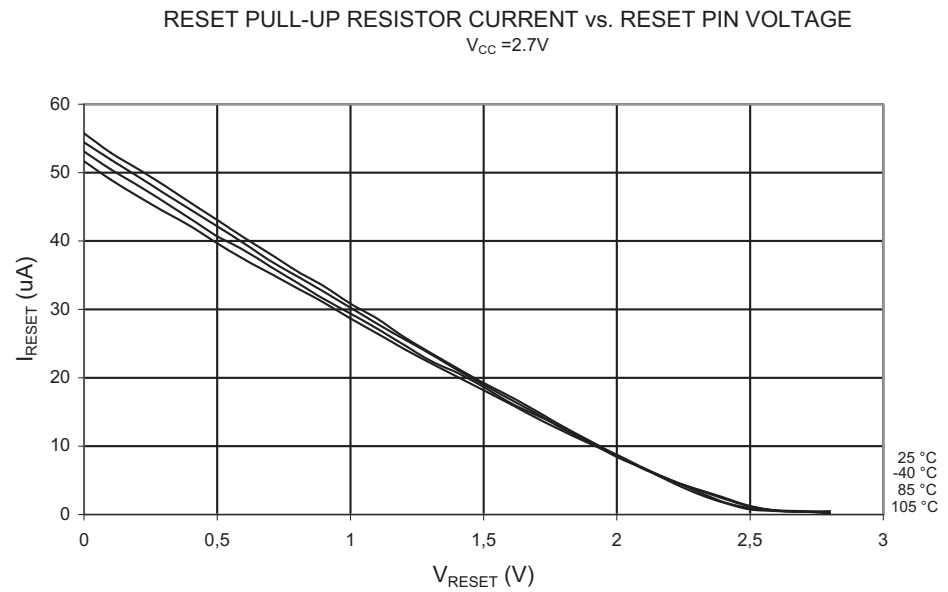
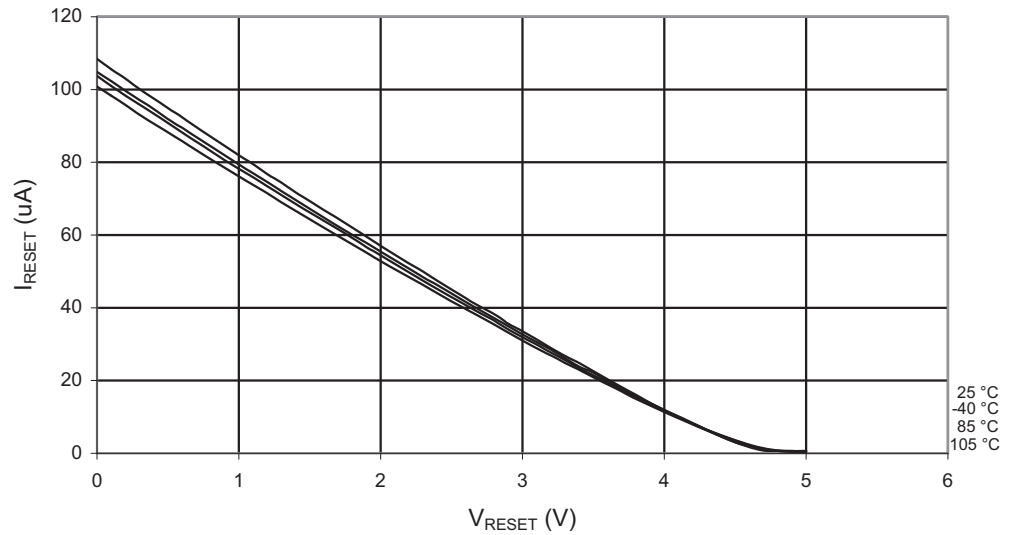

Figure 2-14. Reset Pull-up Resistor Current vs. Reset Pin Voltage ($V_{CC} = 5V$)

RESET PULL-UP RESISTOR CURRENT vs. RESET PIN VOLTAGE
 $V_{CC} = 5V$



2.5 Pin Driver Strength

Figure 2-15. I/O Pin Output Voltage vs. Sink Current ($V_{CC} = 3V$)

I/O PIN OUTPUT VOLTAGE vs. SINK CURRENT
 $V_{CC} = 3V$

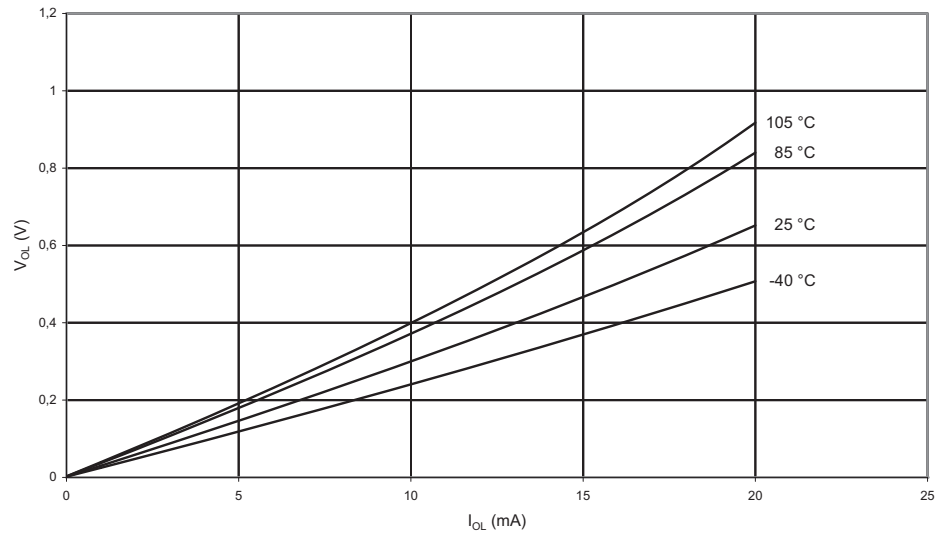

Figure 2-16. I/O Pin Output Voltage vs. Sink Current ($V_{CC} = 5V$)

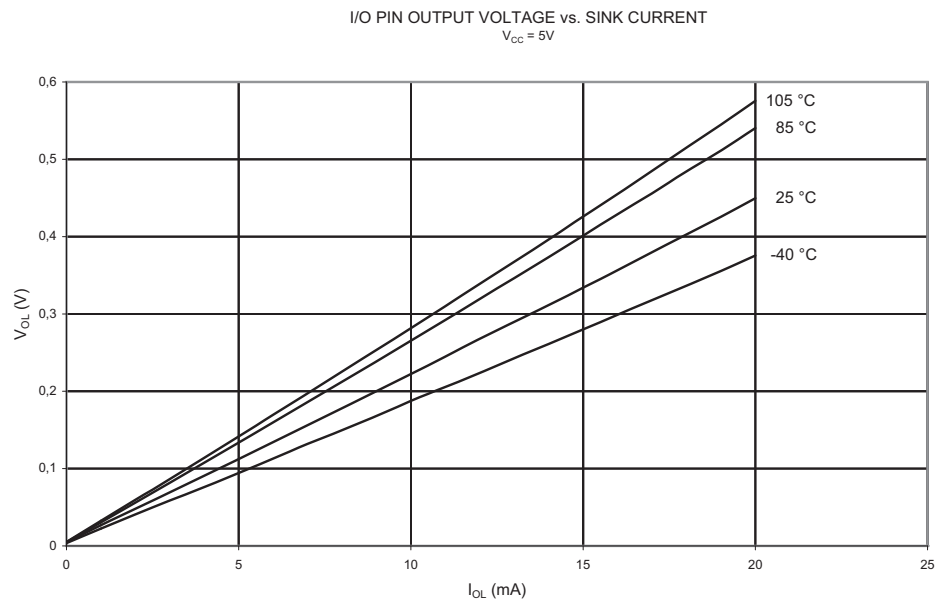

Figure 2-17. I/O Pin Output Voltage vs. Source Current ($V_{CC} = 3V$)

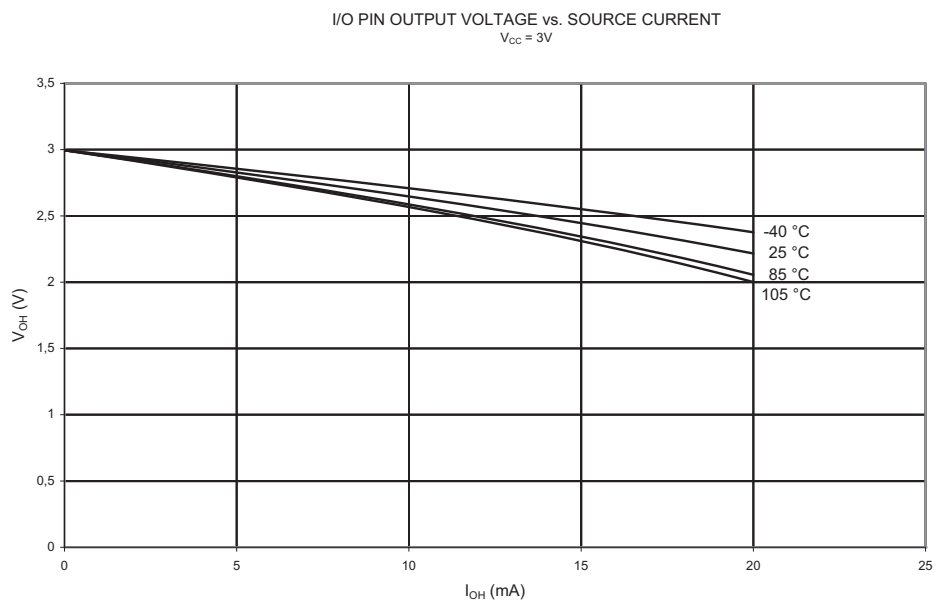

Figure 2-18. I/O Pin Output Voltage vs. Source Current ($V_{CC} = 5V$)

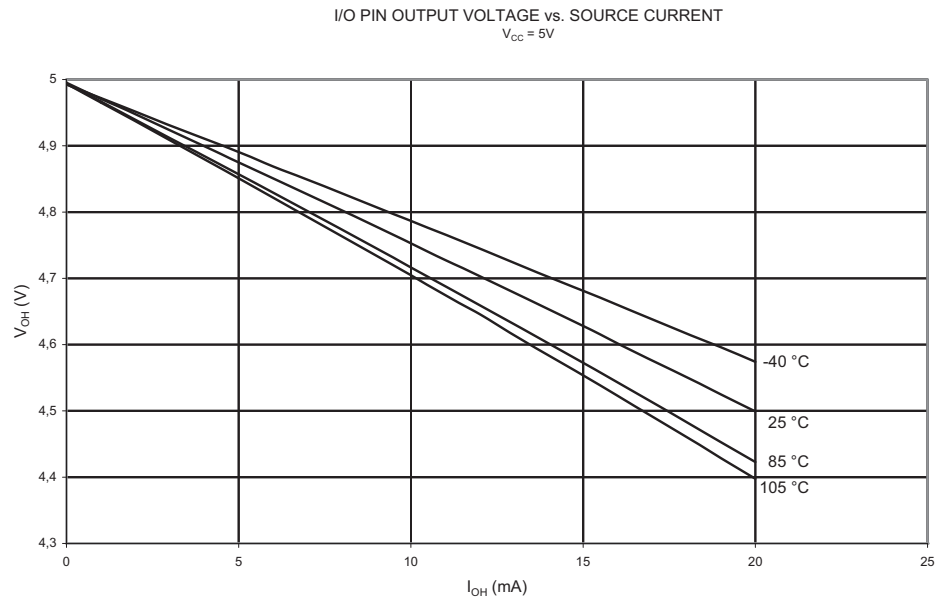

Figure 2-19. Reset Pin Output Voltage vs. Sink Current ($V_{CC} = 3V$)

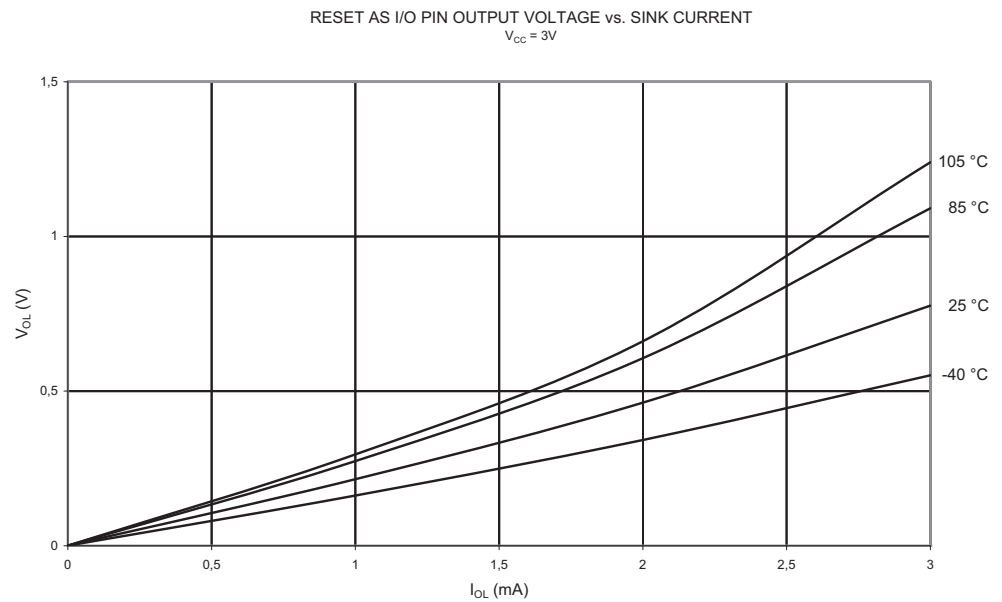

Figure 2-20. Reset Pin Output Voltage vs. Sink Current ($V_{CC} = 5V$)

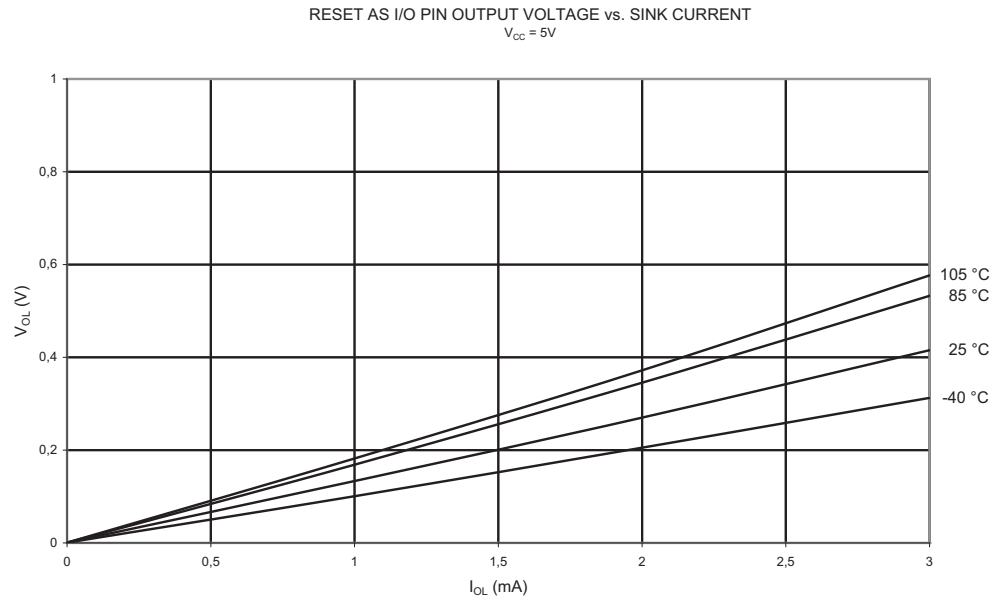

Figure 2-21. Reset Pin Output Voltage vs. Source Current ($V_{CC} = 3V$)

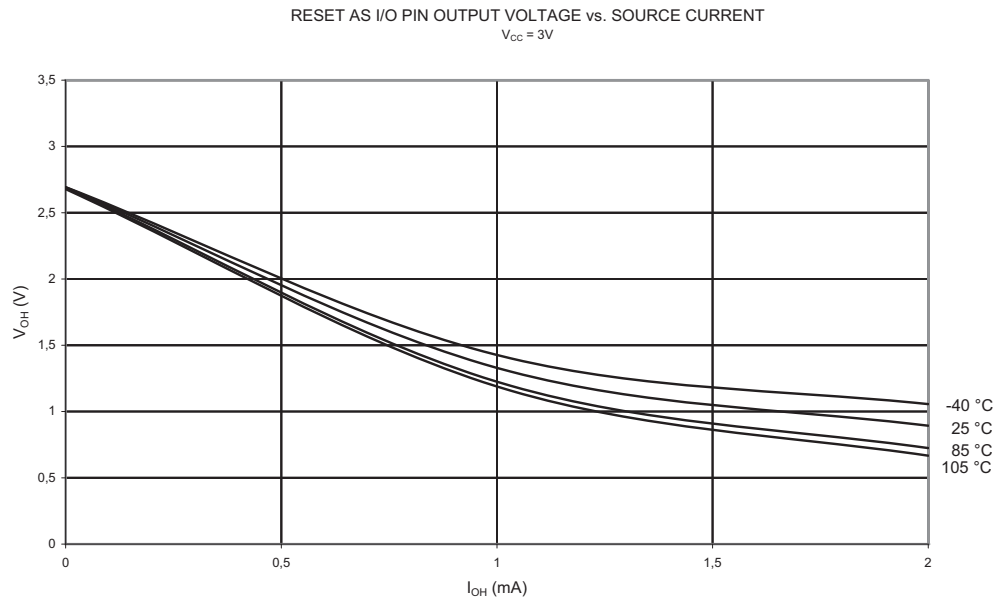
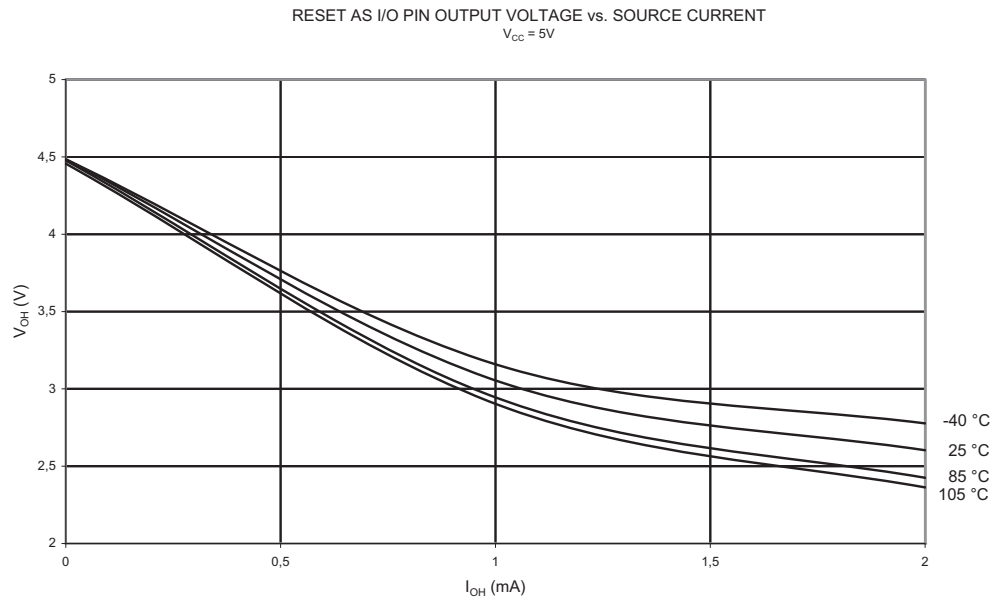

Figure 2-22. Reset Pin Output Voltage vs. Source Current ($V_{CC} = 5V$)



2.6 Pin Threshold and Hysteresis

Figure 2-23. I/O Pin Input Threshold Voltage vs. V_{CC} (V_{IH} , IO Pin Read as '1')

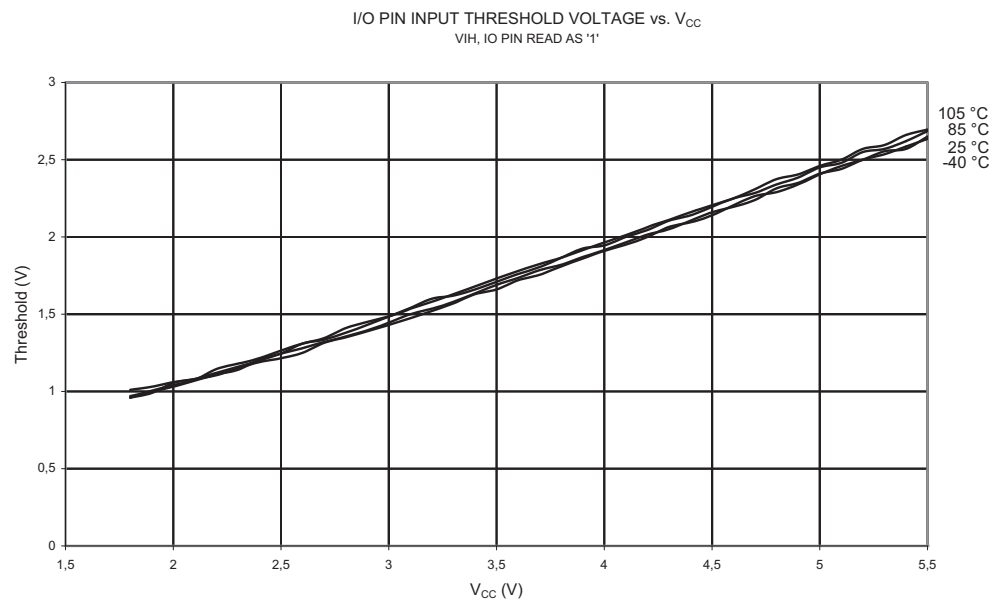

Figure 2-24. I/O Pin Input Threshold Voltage vs. V_{CC} (V_{IL} , IO Pin Read as '0')

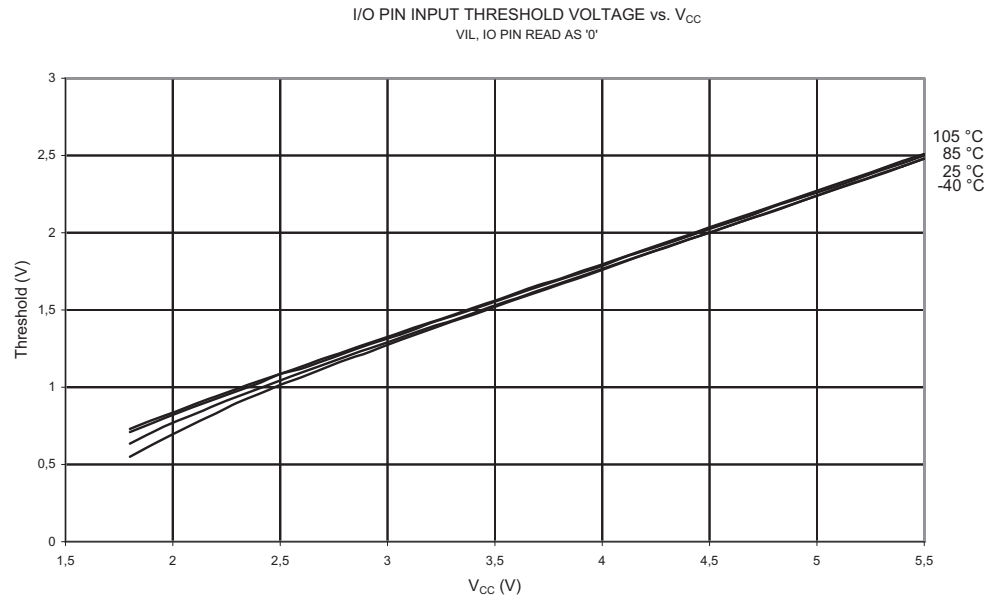

Figure 2-25. I/O Pin Input Hysteresis vs. V_{CC}

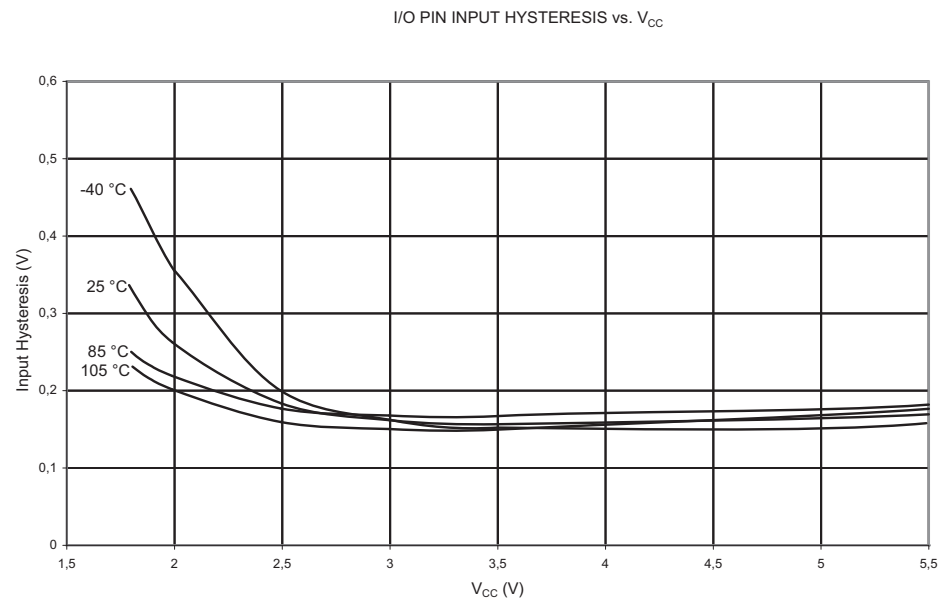

Figure 2-26. Reset Input Threshold Voltage vs. V_{CC} (V_{IH} , IO Pin Read as '1')

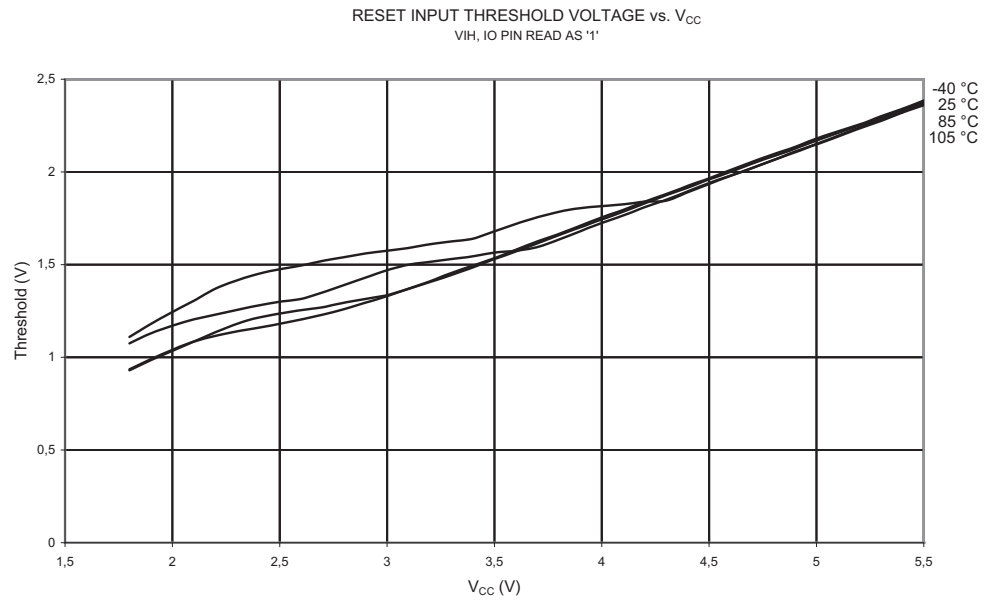

Figure 2-27. Reset Input Threshold Voltage vs. V_{CC} (V_{IL} , IO Pin Read as '0')

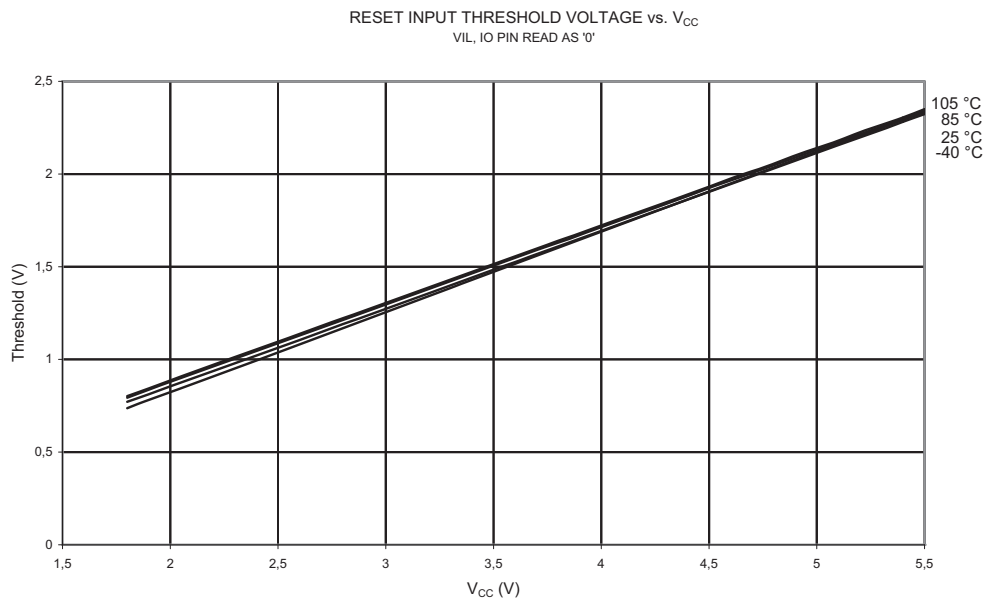
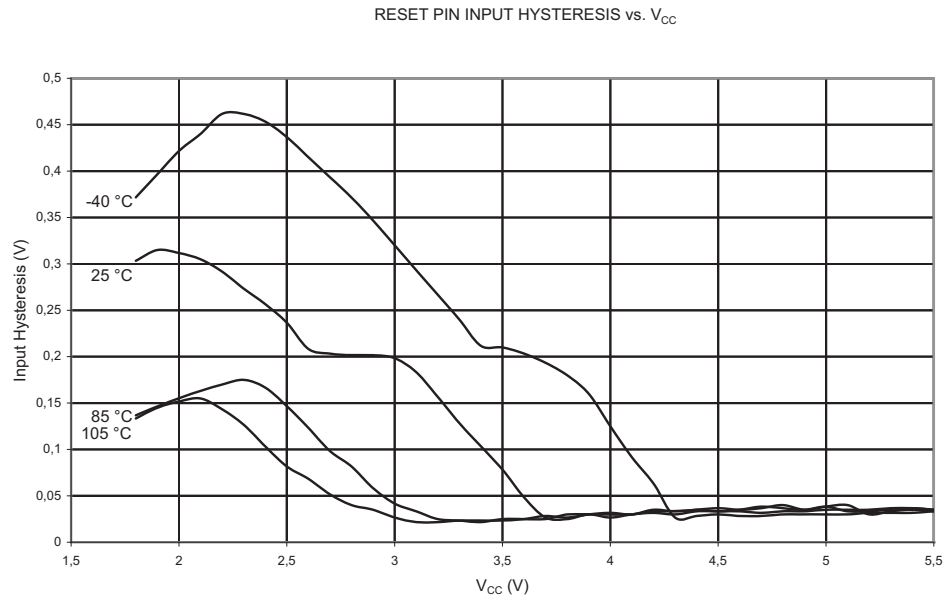

Figure 2-28. Reset Pin Input Hysteresis vs. V_{CC}



2.7 BOD Threshold and Analog Comparator Offset

Figure 2-29. BOD Threshold vs. Temperature (BOD Level is 4.3V)

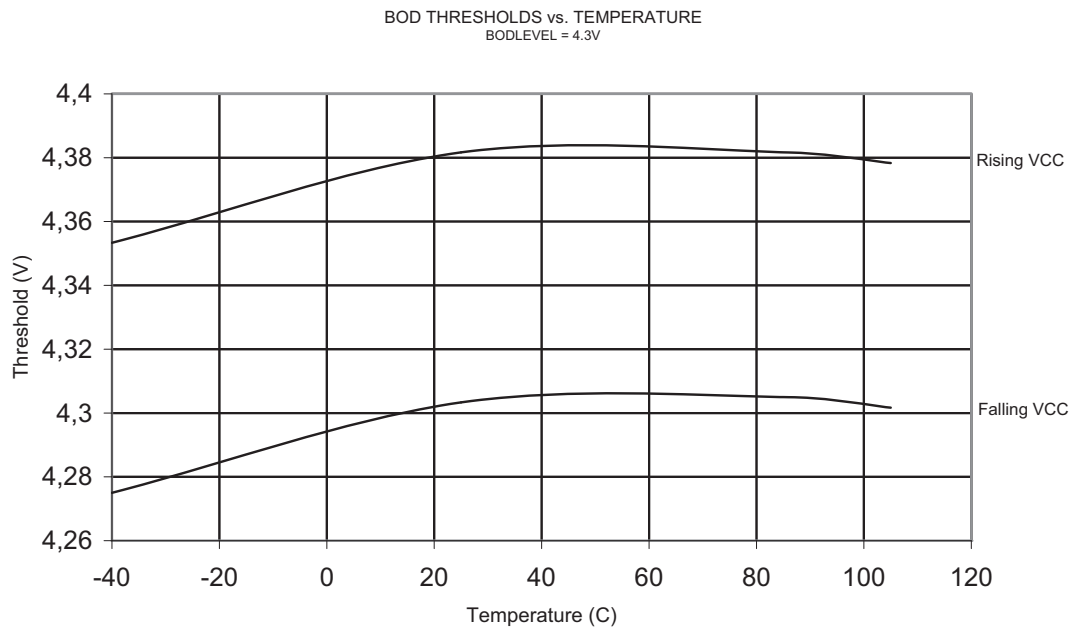

Figure 2-30. BOD Threshold vs. Temperature (BOD Level is 2.7V)

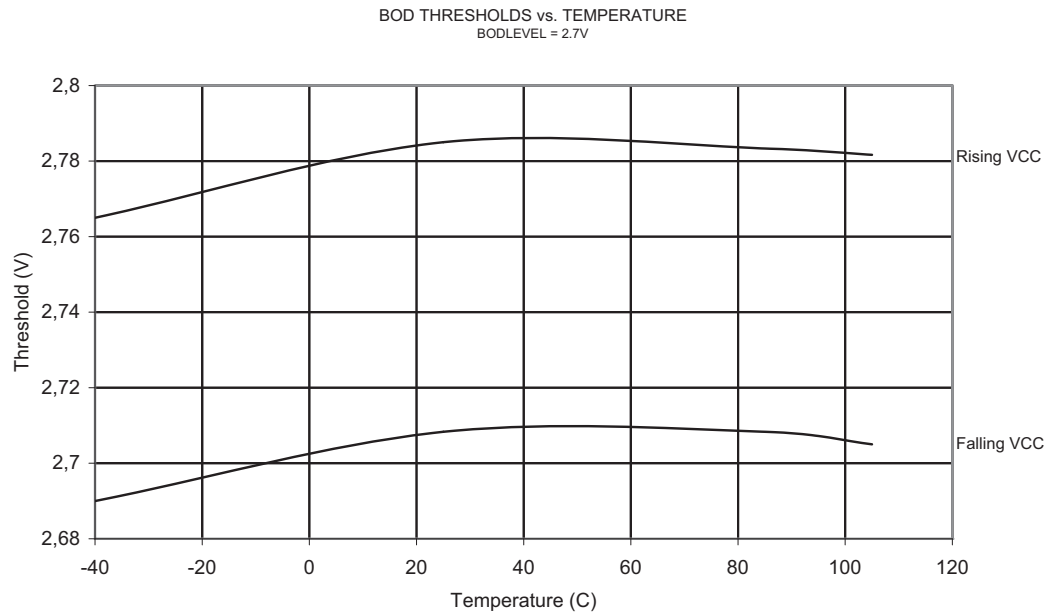

Figure 2-31. BOD Threshold vs. Temperature (BOD Level is 1.8V)

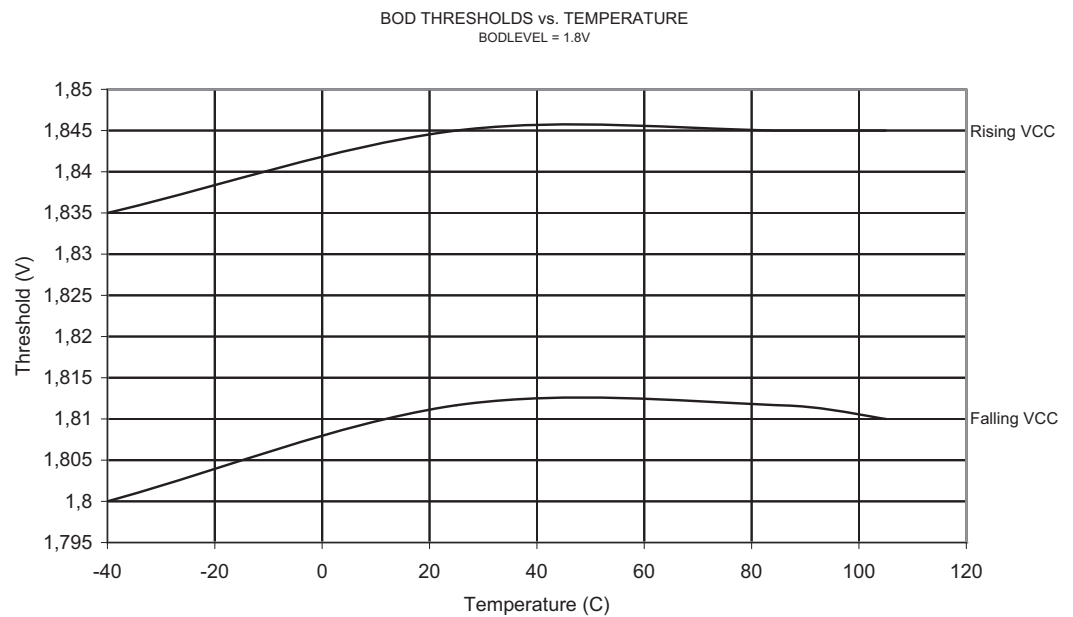

Figure 2-32. Bandgap Voltage vs. Supply Voltage

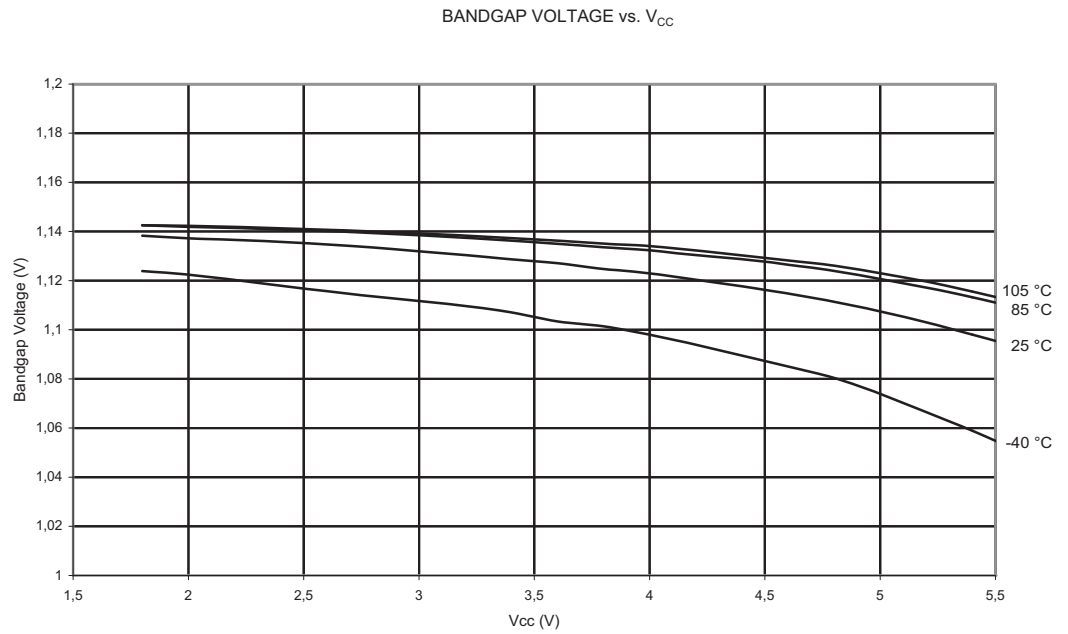
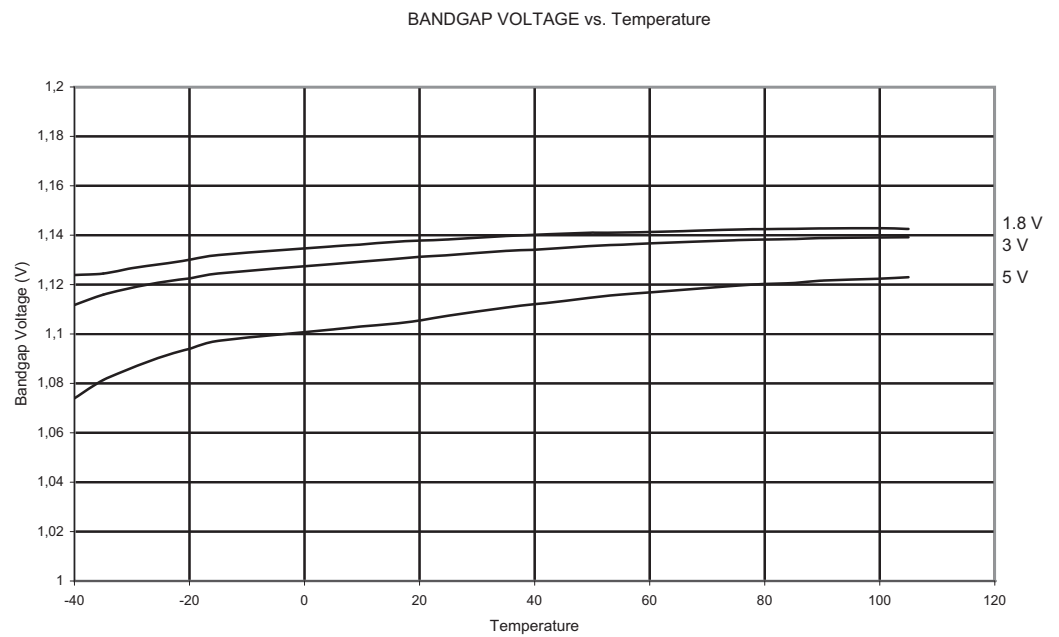

Figure 2-33. Bandgap Voltage vs. Temperature



2.8 Internal Oscillator Speed

Figure 2-34. Watchdog Oscillator Frequency vs. V_{CC}

WATCHDOG OSCILLATOR FREQUENCY vs. V_{CC}

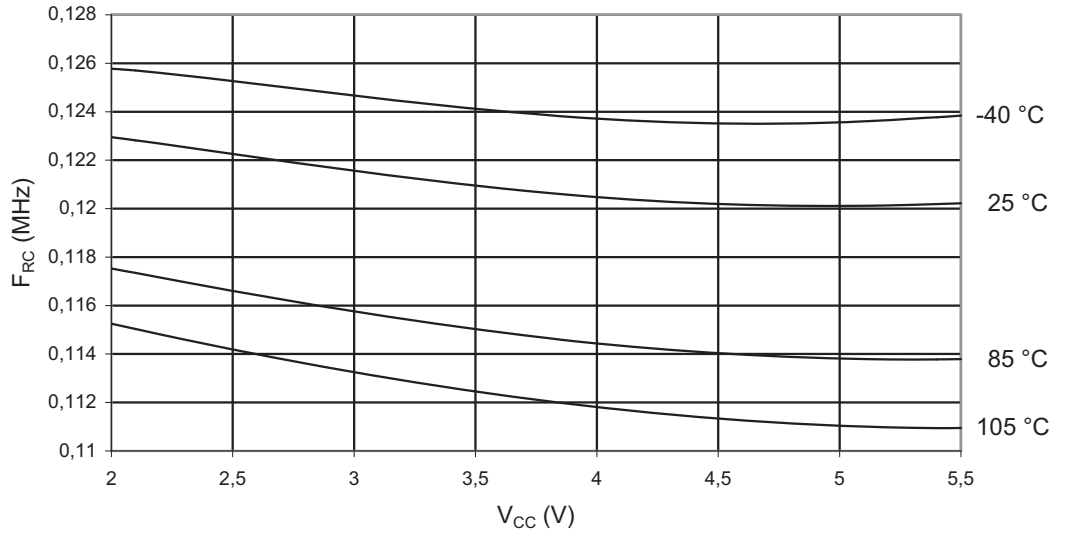

Figure 2-35. Watchdog Oscillator Frequency vs. Temperature

WATCHDOG OSCILLATOR FREQUENCY vs. TEMPERATURE

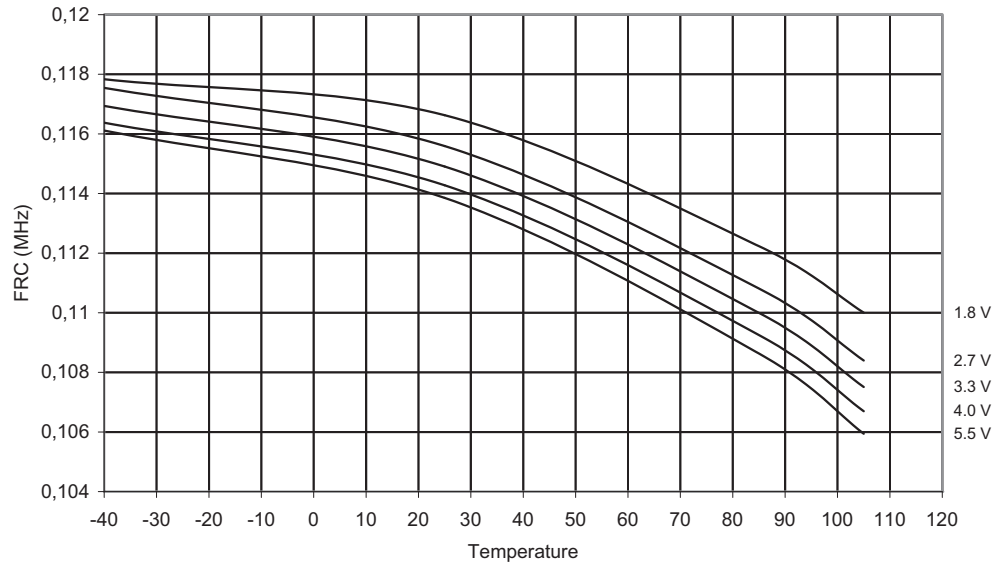

Figure 2-36. Calibrated 8 MHz RC Oscillator Frequency vs. V_{CC}

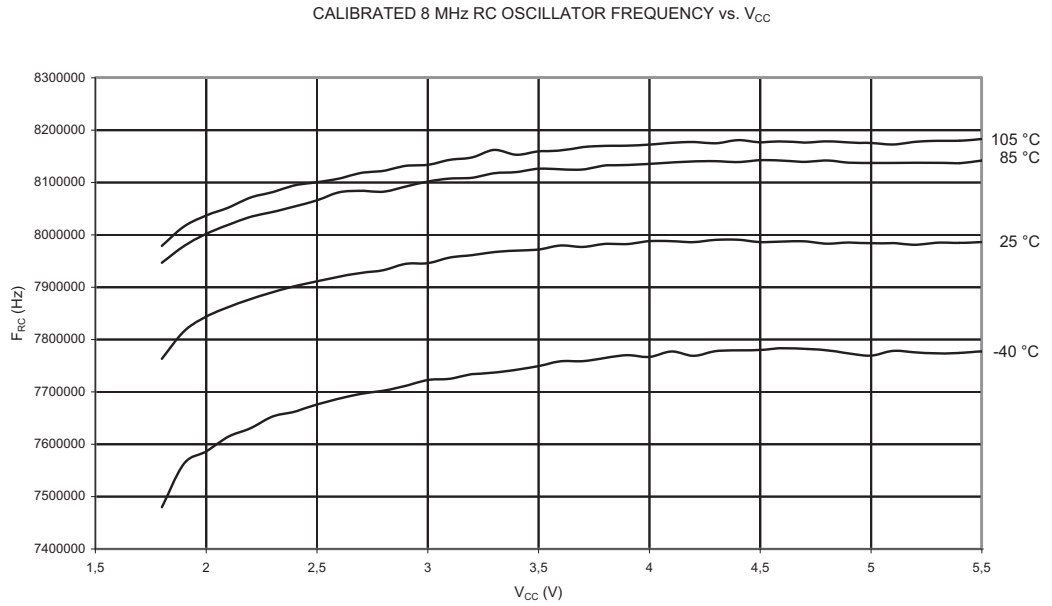

Figure 2-37. Calibrated 8 MHz RC Oscillator Frequency vs. Temperature

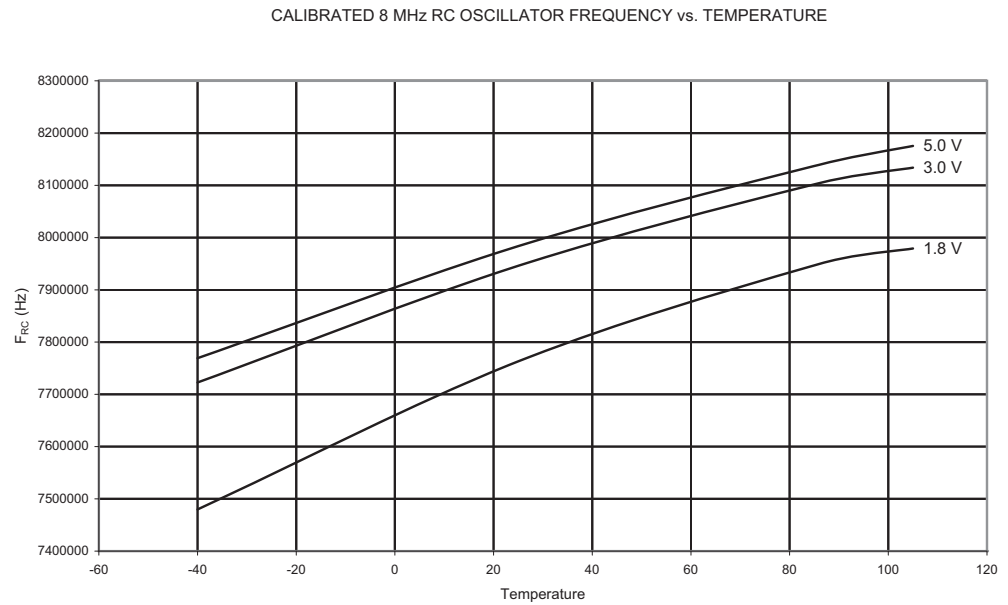
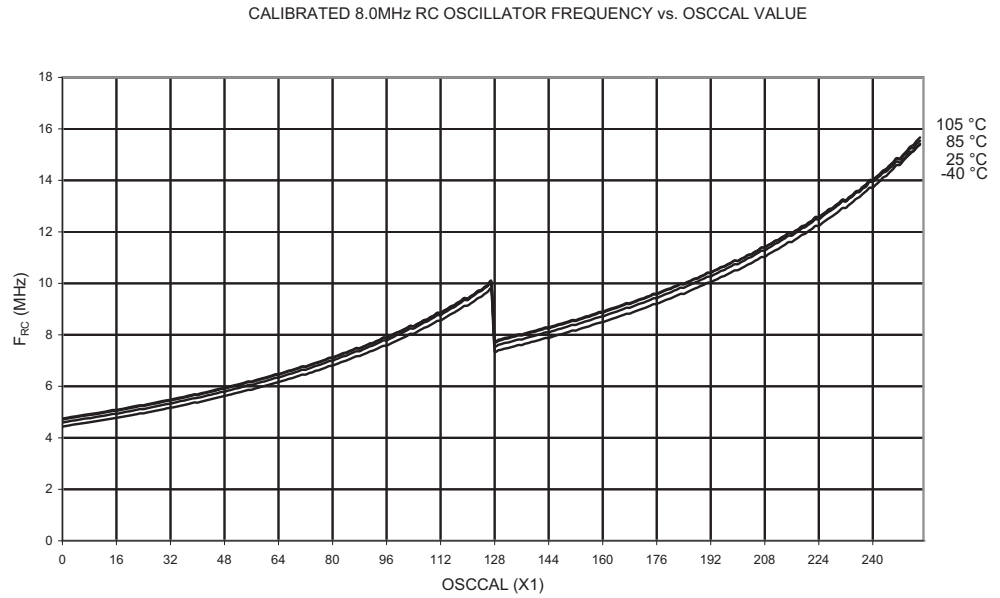

Figure 2-38. Calibrated 8 MHz RC Oscillator Frequency vs. OSCCAL Value



2.9 Current Consumption of Peripheral Units

Figure 2-39. Brownout Detector Current vs. V_{CC}

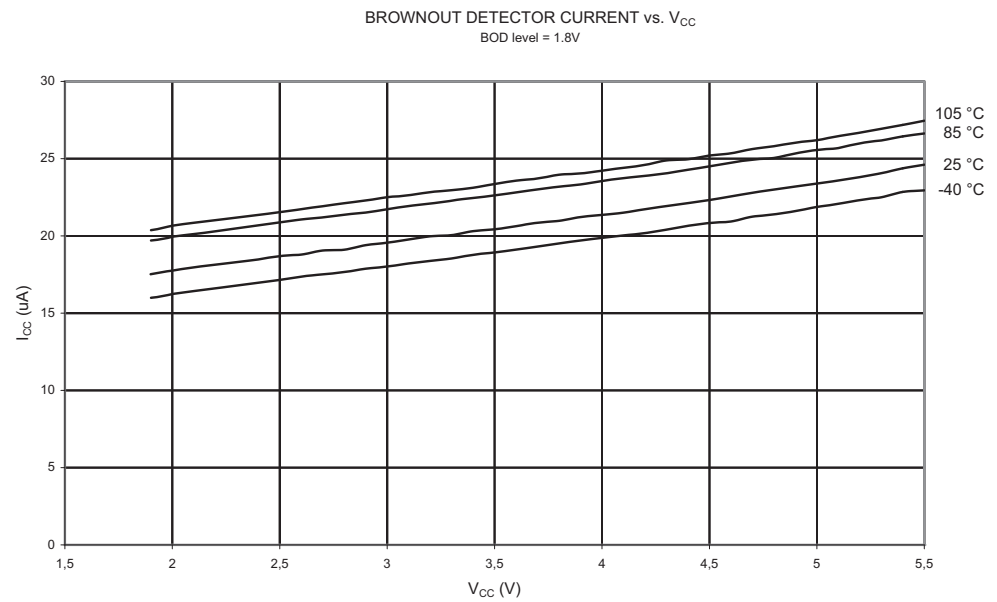

Figure 2-40. ADC Current vs. V_{CC} (AREF = AV_{CC})

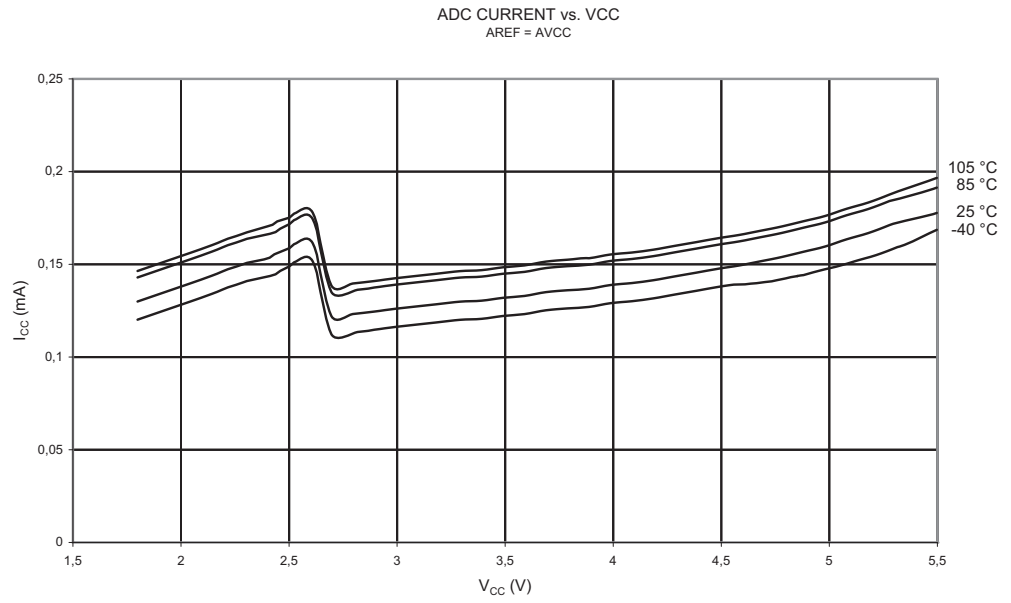

Figure 2-41. Analog Comparator Current vs. V_{CC}

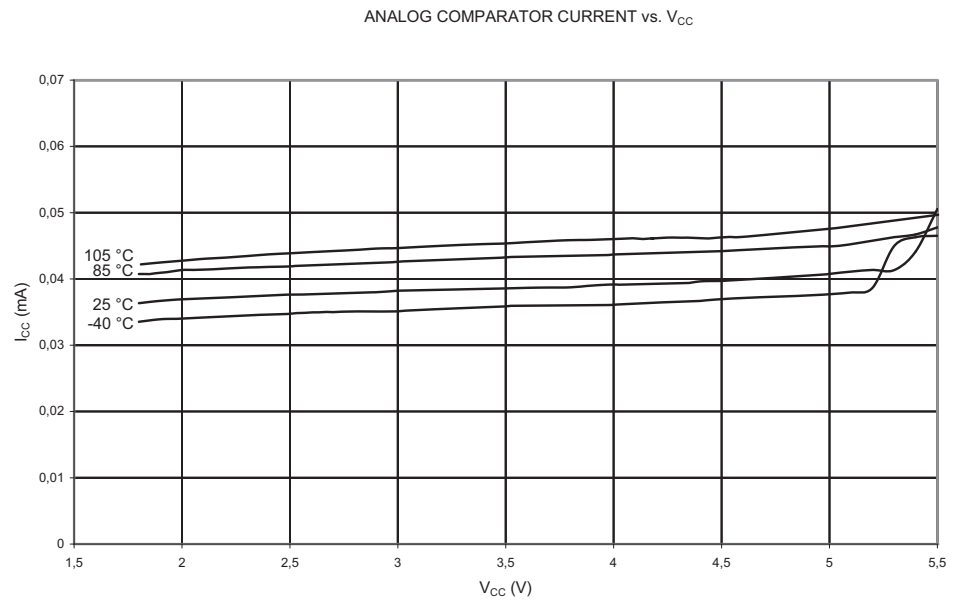
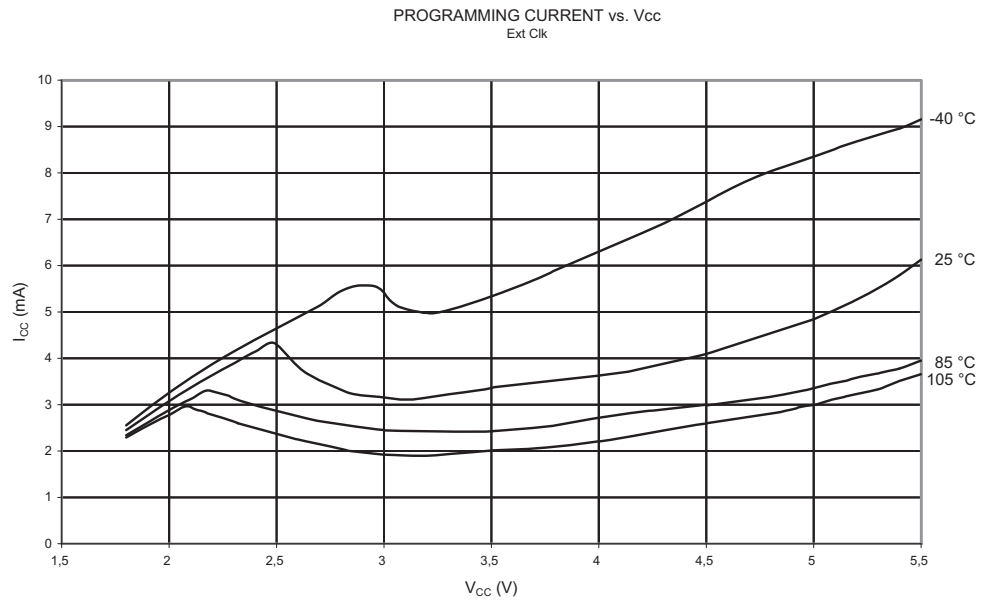
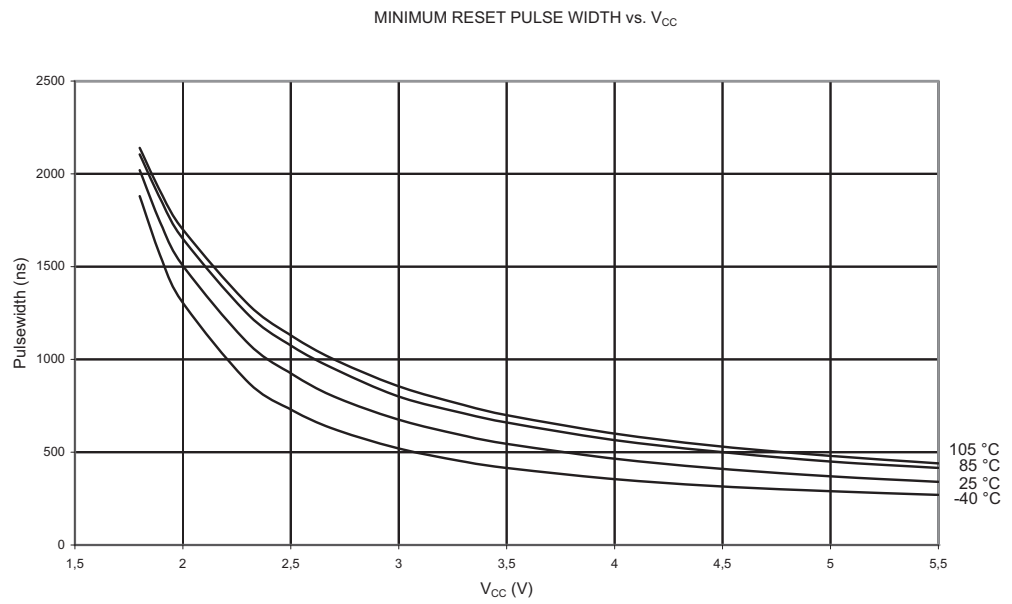

Figure 2-42. Programming Current vs. V_{CC}



2.10 Current Consumption in Reset and Reset Pulsewidth

Figure 2-43. Minimum Reset Pulse Width vs. V_{CC}



3. Ordering Information

Speed (MHz)	Power Supply	Ordering Code ⁽¹⁾	Package ⁽²⁾	Operational Range
10	1.8 - 5.5V	ATtiny25V-10SN ATtiny25V-10SNR ATtiny25V-10SSN ATtiny25V-10SSNR	8S2 8S2 S8S1 S8S1	Industrial (-40°C to +105°C)
20	2.7 - 5.5V	ATtiny25-20SN ATtiny25-20SNR ATtiny25-20SSN ATtiny25-20SSNR	8S2 8S2 S8S1 S8S1	Industrial (-40°C to +105°C)

Notes: 1. Code indicators:

- N: matte tin
- R: tape & reel

2. All packages are Pb-free, halide-free and fully green and they comply with the European directive for Restriction of Hazardous Substances (RoHS).

Package Type	
8S2	8-lead, 0.200" Wide, Plastic Gull-Wing Small Outline (EIAJ SOIC)
S8S1	8-lead, 0.150" Wide, Plastic Gull-Wing Small Outline (JEDEC SOIC)

4. Revision History

Revision No.	History
2586A-Appendix A-AVR-06/10	Initial revision
2586B-Appendix A-AVR-07/10	Added Ordering Codes -SN and -SNR (package 8S2)
2586N-Appendix A-AVR-08/11	Removed "Preliminary" status, updated contact information



Headquarters

Atmel Corporation

2325 Orchard Parkway
San Jose, CA 95131
USA
Tel: (+1)(408) 441-0311
Fax: (+1)(408) 487-2600

International

Atmel Asia Limited

Unit 01-5 & 16, 19F
BEA Tower, Millennium City 5
418 Kwun Tong Road
Kwun Tong, Kowloon
HONG KONG
Tel: (+852) 2245-6100
Fax: (+852) 2722-1369

Atmel Munich GmbH

Business Campus
Parking 4
D-85748 Garching b. Munich
GERMANY
Tel: (+49) 89-31970-0
Fax: (+49) 89-3194621

Atmel Japan

9F, Tonetsu Shinkawa Bldg.
1-24-8 Shinkawa
Chuo-ku, Tokyo 104-0033
JAPAN
Tel: (+81)(3) 3523-3551
Fax: (+81)(3) 3523-7581

Product Contact

Web Site

www.atmel.com

Technical Support

avr@atmel.com

Sales Contact

www.atmel.com/contacts

Literature Requests

www.atmel.com/literature

Disclaimer: The information in this document is provided in connection with Atmel products. No license, express or implied, by estoppel or otherwise, to any intellectual property right is granted by this document or in connection with the sale of Atmel products. **EXCEPT AS SET FORTH IN ATMEL'S TERMS AND CONDITIONS OF SALE LOCATED ON ATMEL'S WEB SITE, ATMEL ASSUMES NO LIABILITY WHATSOEVER AND DISCLAIMS ANY EXPRESS, IMPLIED OR STATUTORY WARRANTY RELATING TO ITS PRODUCTS INCLUDING, BUT NOT LIMITED TO, THE IMPLIED WARRANTY OF MERCHANTABILITY, FITNESS FOR A PARTICULAR PURPOSE, OR NON-INFRINGEMENT. IN NO EVENT SHALL ATMEL BE LIABLE FOR ANY DIRECT, INDIRECT, CONSEQUENTIAL, PUNITIVE, SPECIAL OR INCIDENTAL DAMAGES (INCLUDING, WITHOUT LIMITATION, DAMAGES FOR LOSS OF PROFITS, BUSINESS INTERRUPTION, OR LOSS OF INFORMATION) ARISING OUT OF THE USE OR INABILITY TO USE THIS DOCUMENT, EVEN IF ATMEL HAS BEEN ADVISED OF THE POSSIBILITY OF SUCH DAMAGES.** Atmel makes no representations or warranties with respect to the accuracy or completeness of the contents of this document and reserves the right to make changes to specifications and product descriptions at any time without notice. Atmel does not make any commitment to update the information contained herein. Unless specifically provided otherwise, Atmel products are not suitable for, and shall not be used in, automotive applications. Atmel's products are not intended, authorized, or warranted for use as components in applications intended to support or sustain life.

© 2011 Atmel Corporation. All rights reserved.

Atmel®, logo and combinations thereof, and others are registered trademarks or trademarks of Atmel Corporation or its subsidiaries. Other terms and product names may be trademarks of others.